

TELOS Z/IP ONE

Intelligent Zephyr IP codec with Agile Connection Technology™



USER'S MANUAL

Manual v2.0.1 for software version 2.0.1r and higher
August 2014

Z/IP ONE Manual

© 2014 TLS Corporation. Published by Telos Systems/TLS Corporation. All rights reserved.

Trademarks

Telos Systems, the Telos logo and Z/IP ONE are trademarks of TLS Corporation. All other trademarks are the property of their respective holders.

Notice

All versions, claims of compatibility, trademarks, etc. of hardware and software products not made by Telos mentioned in this manual or accompanying material are informational only. Telos Systems makes no endorsement of any particular product for any purpose, nor claims any responsibility for operation or accuracy. We reserve the right to make improvements or changes in the products described in this manual which may affect the product specifications, or to revise the manual without notice.

Warranty

This product is covered by a five year limited warranty, the full text of which is included in this manual.

Updates

The operation of the Z/IP ONE is determined largely by software. We routinely release new versions to add features and fix bugs. Check the Telos web site for the latest. We encourage you to sign-up for the email notification service offered on the site.

Feedback

We welcome feedback on any aspect of the Z/IP ONE, or this manual. In the past, many good ideas from users have made their way into software revisions or new products. Please contact us with your comments.

Service

You must contact Telos before returning any equipment for factory service. We will need the serial number, located on the back of the unit. Telos Systems will issue a Return Authorization number which must be written on the exterior of your shipping container. Please do not include cables or accessories unless specifically requested by the technical support engineer at Telos. Be sure to adequately insure your shipment for its replacement value. Packages without proper authorization may be refused. US customers please contact Telos technical support at +1-216-622-0247. All other customers should contact your local representative to make arrangements for service.

We support you...

By Phone / Fax:

You may reach our 24/7 Support Team anytime around the clock by calling +1-216-622-0247.

For billing questions or other non-emergency technical questions, call +1-216-241-7225 between 9:30 AM to 6:00 PM USA Eastern Time, Monday through Friday.

Our fax is +1-216-241-4103.

By E-Mail:

Technical support is available at Support@Telos-Systems.com.

All other inquiries at Inquiry@Telos-Systems.com.

Via World Wide Web:

The Telos Web site has a variety of information which may be useful for product selection and support.

The URL is www.Telos-Systems.com

10987654321

Telos Systems USA
Telos Systems
1241 Superior Avenue E
Cleveland, OH 44114 USA
+1-216-241-7225 (phone)
+1-216-241-4103 (fax)
+1-216-622-0247 (24/7 Technical Support)
Support@Telos-Systems.com
Inquiry@Telos-Systems.com

Notices and Cautions



This symbol, wherever it appears, alerts you to the presence of uninsulated, dangerous voltage inside the enclosure – voltage which may be sufficient to constitute a risk of shock.



This symbol, wherever it appears, alerts you to important operating and maintenance instructions. Read the manual.

CAUTION:

THE INSTALLATION AND SERVICE INSTRUCTIONS IN THIS MANUAL ARE FOR USE BY QUALIFIED PERSONNEL ONLY. TO AVOID ELECTRIC SHOCK, DO NOT PERFORM ANY SERVICING OTHER THAN THAT CONTAINED IN THE OPERATING INSTRUCTIONS UNLESS YOU ARE QUALIFIED TO DO SO. REFER ALL SERVICING TO QUALIFIED PERSONNEL.

THIS INSTRUMENT HAS AN AUTORANGING LINE VOLTAGE INPUT. ENSURE THE POWER VOLTAGE IS WITHIN THE SPECIFIED RANGE. THE ~ SYMBOL, IF USED, INDICATES AN ALTERNATING CURRENT SUPPLY.

WARNING:

THE PRODUCT'S POWER CORD IS THE PRIMARY DISCONNECT DEVICE. THE SOCKET OUTLET SHOULD BE LOCATED NEAR THE DEVICE AND EASILY ACCESSIBLE. THE UNIT SHOULD NOT BE LOCATED SUCH THAT ACCESS TO THE POWER CORD IS IMPAIRED. IF THE UNIT IS INCORPORATED INTO AN EQUIPMENT RACK, AN EASILY ACCESSIBLE SAFETY DISCONNECT DEVICE SHOULD BE INCLUDED IN THE RACK DESIGN.

TO REDUCE THE RISK OF ELECTRICAL SHOCK, DO NOT EXPOSE THIS PRODUCT TO RAIN OR MOISTURE. THIS UNIT IS FOR INDOOR USE ONLY.

USA CLASS A COMPUTING DEVICE INFORMATION TO USER. WARNING:

This equipment generates, uses, and can radiate radio-frequency energy. If it is not installed and used as directed by this manual, it may cause interference to radio communication. This equipment complies with the limits for a Class A computing device, as specified by FCC Rules, Part 15, Subpart J, which are designed to provide reasonable protection against such interference when this type of equipment is operated in a commercial environment. Operation of this equipment in a residential area is likely to cause interference. If it does, the user will be required to eliminate the interference at the user's expense. NOTE: Objectionable interference to TV or radio reception can occur if other devices are connected to this device without the use of shielded interconnect cables. FCC rules require the use of shielded cables.

CANADA WARNING:

"This digital apparatus does not exceed the Class A limits for radio noise emissions set out in the Radio Interference Regulations of the Canadian Department of Communications."

"Le présent appareil numérique n'émet pas de bruits radioélectriques dépassant les limites applicables aux appareils numériques (de Class A) prescrites dans le Règlement sur le brouillage radioélectrique édicté par le ministère des Communications du Canada."

1	<i>Introduction</i>	<i>1</i>
2	<i>Quick Start Guide</i>	<i>3</i>
	2.1 Unpack and Identify	3
	2.2 The ZIP/ONE User Interface	4
	2.3 Setup Wizard	4
	2.4 Make Your First IP-Codec Call	6
	2.5 Congratulations!	7
	Codec Features	8
	Codec Characteristics	9
3	<i>Installation</i>	<i>11</i>
	3.1 Rack Mounting the Studio Unit	11
	3.2 Power	11
	3.3 Audio Inputs (balanced analog)	11
	3.4 Audio Outputs (balanced analog)	12
	3.5 Network Interfaces	12
	3.6 USB Ports	12
	3.7 Network Interfaces	12
	3.8 USB Ports	13
	3.9 Parallel Control	13
4	<i>The Front Panel Interface</i>	<i>15</i>
	4.1 Front Panel Controls	15
	4.2 The User Interface and Menu System.	17
5	<i>The Audio I/O Menu</i>	<i>19</i>
	5.2 Input Mode	20
	5.3 Microphone-level Gain	20
	5.4 Line-level Gain	20
	5.5 Transmit Mode	20
	5.6 AES/EBU Output Sample Rate	20
	5.7 Loopback	20

6	<i>The Setup Menu</i>	21
	6.1 Network	21
	6.2 Audio Codec	24
	6.3 System	26
	6.4 Software	26
	6.5 Setup Wizard	27
	6.6 ZIP Server	27
	6.7 Parallel Port	28
7	<i>The Status Screens</i>	29
	7.1 Overview	29
	7.2 Call Status + GPIO	30
	7.3 Call Status + Codec	30
	7.4 Network Interface Status Screens	31
	7.5 Version Info	32
8	<i>The Web Interface</i>	33
	8.1 Status Page	33
	8.2 Connect	34
	8.3 Audio, Streaming, GPIO, and System	35
	8.4 Network	35
	8.5 Software Management	35
	8.6 Quick Start and Manual	36
	8.7 Logs	36
9	<i>Audio Streams</i>	37
	9.1 Telos Session Control Protocol	37
	9.2 N/ACIP Session Initiation Protocol	40
	9.3 Real-time Transport Protocol	41
10	<i>Making Connections</i>	43
	10.1 Dialing Manually	43
	10.2 Using the Phone Book	44
	10.3 Call History	46

11	<i>Mobile Network Devices</i>	47
	11.1 WiFi/WLAN Networks	47
	11.2 UMTS/EVDO Wireless Networks	47

12	<i>Ancillary Data</i>	49
	12.1 GPIO	49
	12.2 Serial Data	54

Appendix A	<i>When an IT Department is not Available</i>	55
	IP Addresses, Subnet masks, and Gateways	55
	Discover the Local Network Settings.	58
	Find an Available IP Address without a DHCP Server	60
	Duplicate IP Addresses.	61
	Network Address Translation	62

Appendix B	<i>Audio Coding Reference</i>	65
	History.	65
	Basic Principles of Perceptual Coding	66
	MPEG	69
	MPEG4 AAC (Advanced Audio Coding)	69
	AAC-LD (AAC Low Delay)	72
	MPEG-4 High Efficiency AAC (HE-AAC, previously known as "aacPlus™").	74
	MPEG-4 Enhanced Low Delay AAC	74
	ISO/MPEG Layer 2	74
	G.722	74
	aptX and aptX Enhanced	75

Z/IP ONE Audio Specifications	77
--------------------------------------	----

Warranty and Application Cautions	79
--	----

Safety Notification	81
----------------------------	----

1 Introduction

Congratulations on your purchase of the Telos Z/IP ONE! This codec achieves a new level in IP Audio transmission at a very attractive price. It is a one RU unit intended to be used with a microphone directly, or an external mixer for remote broadcasts, or anywhere space is at a premium.



The Telos Z/IP ONE combines RTP/UDP streaming capabilities with MPEG coding to deliver broadcast-quality audio over IP connections. Z/IP ONE employs sophisticated new technology to achieve superb audio quality over IP networks such as the Internet and mobile IP services. The Z/IP ONE utilizes ACT™ - Agile Connection Technology to continually adapt to network conditions, minimizing the effects of packet loss, varying bandwidth, and jitter that can occur on these networks by means of sophisticated error detection and concealment, dynamic buffering, and other techniques that work together to provide reliable IP audio connections.

The Z/IP ONE has an impressive list of features, including:

- ◆ Analog line professional or microphone input levels
- ◆ AES/EBU digital input and output
- ◆ 15 volt phantom power for direct use with condenser microphones
- ◆ Transmission bit rates from 8kbps to 2304 kbps
- ◆ User-friendly front panel interface with OLED screen
- ◆ Real-time metering and connection status display screen
- ◆ Context-sensitive on-screen help available at a touch of a button
- ◆ EBU N/ACIP (Audio Contribution over IP) and SIP interoperability with other third party codecs
- ◆ Backward compatible with the Telos Zephyr Xstream, as well as the original Zephyr/IP
- ◆ Built-in web server for configuration and remote control
- ◆ Wireless connection through Wi-Fi and 3G/4G/EVDO modems (Wi-Fi modem included)
- ◆ Livewire™ audio-over-IP inputs and outputs
- ◆ Separate LAN and WAN Ethernet ports simplify isolation of your LAN from the internet
- ◆ The ability to register with a “directory server” (ZIP Server) . This allows establishing a connection even when located behind NATs and firewalls, without knowing the other party’s IP address
- ◆ Router Mode allows the Z/IP ONE to be used as a gateway to access the Web

2 Quick Start Guide

This quick start will guide you through a basic, yet perfectly usable setup scenario of the Telos Z/IP ONE IP audio codec. More sophisticated configurations are available, and are preferred or even necessary in some IP network situations.

2.1 Unpack and Identify

Your Z/IP ONE is shipped with a few accessories that we won't use for this initial setup, but you may want to use later. For now, we'll want the Z/IP ONE itself, AC power cord, and a network cable – all included with the Z/IP ONE.



To test the Z/IP ONE, you'll also need:

1. Headphones – or connect the Z/IP ONE's audio output to an audio monitor.
2. Microphone or audio source (optional)
3. An Internet-connected Local Area Network with DHCP Server (You may set your Z/IP ONE's network configuration manually if you prefer)

The basic steps to follow are:

1. Attach AC power cable and power up
2. Follow the built-in Setup Wizard
3. Connect to the Internet
4. Make your first call

2.2 The Z/IP ONE User Interface

The Z/IP ONE uses an OLED display for status, metering, and configuration. There are six menus available:



Turning the Z/IP ONE's control knob will move the highlight between these options. The name shown in the middle of this screen is the device's identity on the ZIP Server, used for making calls without having to memorize IP addresses.

Z/IP ONEs with software earlier than v2.0.0r, such as the one shown above, had the version number printed on the main screen instead. If your Z/IP ONE is not running at least v2.0.0r, please update your codec to the latest released version of software. The latest version is always listed and available for download here:

<http://www.telos-systems.com/codexs/zip-one/>

If the front panel controls are not used for a short period of time, the display will revert back to a status screen (by default, the last status screen viewed):



2.3 Setup Wizard

One option for initial setup of the Z/IP ONE is using the built-in Setup Wizard. The Setup Wizard will work in most common IP networks, and requires little technical knowledge. Let's walk through it:

From the Main menu, highlight and select Setup.



From the Setup menu, highlight and select Setup Wizard.



Click to Continue.

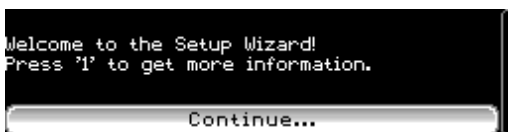

Select the WAN Ethernet connection.



Select the Analog XLR connectors for audio input.

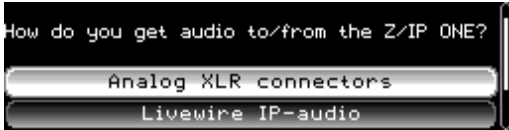

Answer "Yes" to allow control of your unit from either port.

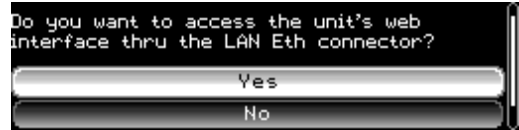

Let's answer "No" to the SIP server question.

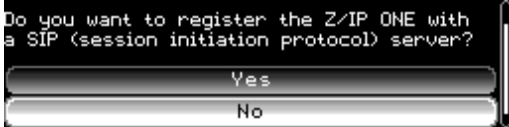

Keep this easy; answer "Yes" here.



Answer "Yes" here. We'll use this port.



Using the keypad, enter a name for this Z/IP ONE.

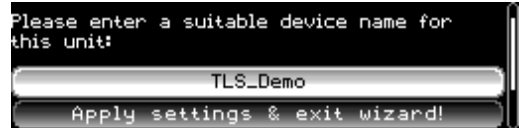

Then click to Apply settings and exit

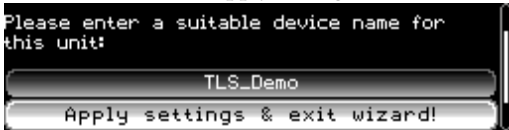

Click OK to complete the Setup Wizard.

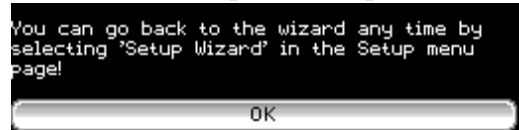

Plug your Internet-connected network to the WAN port.

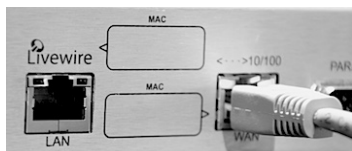

Then, highlight and select Status.



The top Status screen should show WAN connected.



Within a few seconds, the ZIP light should come on, too.



The ZIP indicator is your assurance that your Z/IP ONE is communicating with the Telos ZIP Server, and that connections to other Z/IP ONES and Zephyr/IPs are just two button presses away.

What if the ZIP indicator doesn't light up? This condition is usually caused by a very restrictive network firewall, a non-standard DNS configuration, or not having DHCP available to obtain an IP address automatically. Appendix A offers information and suggestions about working through restrictive network firewalls and alternatively configuring DNS.

2.4 Make Your First IP-Codec Call

Now that the WAN and ZIP indicators are ON, you're ready to make your first Z/IP ONE IP call. Press the AUTO button - it's in the upper right corner of the keypad area. This brings up the phone book - a quick-dial list of the other Z/IP ONEs you'd like to connect with.



Your Z/IP ONE is factory programmed with two contacts - the Telos Line in Cleveland, Ohio, USA, and the Euro Line in Freising, Germany. Highlight "Telos Line" and press the AUTO button again (or push the main control knob) to establish a call. As the call progresses and connects, the screen changes automatically to the main Status display.



The large *Connect* indicator should come ON quickly, followed a few seconds later by the *RcvLock* indicator. The *Rcv* audio level meters will begin showing moving audio levels. In a few more seconds the *Buffer* and *Quality* gauges in the lower third of the screen will show relative indications of receive buffer size at both ends and quality of the connection, indicating dropped packets.

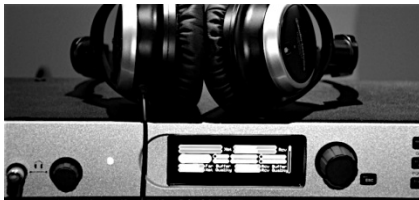

Plug your favorite headphones into the front panel headphone jack. Adjust the volume knob that's next to the jack for a comfortable level. You'll hear whatever music our Support Engineers have selected. Don't be alarmed when the Z/IP ONE automatically disconnects from the Telos test line. It will time out and hang up after 10 minutes. This is to allow others to test Z/IP ONE connections, too.

2.5 Congratulations!

You've configured your Z/IP ONE and made your first IP-codec call. There are dozens of configuration options within the Z/IP ONE, allowing it to work ideally in different broadcast and remote-audio roles. Consult the manual, our online video tutorials, or Telos Support to get the most out of your Z/IP ONEs.

Info for IT experts:

You may choose to configure either the WAN or LAN port for streaming connections. We recommend using the WAN port, saving the LAN (also Livewire) port for Livewire AoIP network connections.

Z/IP ONE connection success is virtually guaranteed by assigning it an unused static IP address on your network, assigning a fixed "ZIP Server Listen Port" in the ZIP Server menu, and configuring a port forward from the Internet side of your firewall/router to the static IP address of your Z/IP ONE, using that same "Listen Port" number. We suggest you choose a listen port in the 20000-21000 range to avoid port conflicts. Left unassigned, as in this Quick Start, the Z/IP ONE negotiates a listening port with the ZIP Server. The ZIP Server is always located at zip.telos-systems.com, which is the factory default setting. Incoming calls to the Z/IP ONE will connect instantly if a fixed listen port is chosen and a port forward made. Otherwise, each inbound call negotiation will take five to ten seconds.

Placing the Z/IP ONE on a DMZ or un-NATted Public IP address is not recommended. A good choice for a manually-configured DNS address is 8.8.8.8.

...Now what?

Most hardware codecs, such as the Telos Z/IP ONE, Telos ProSTREAM, and Telos iPort, offer a choice of audio coding algorithms. With unhelpful names like “G.722”, “AAC-LD”, and “Layer 2”, how does one choose the best coding algorithm for a given connection or use? A full discussion of audio coding is in Appendix B, *Audio Coding Reference*, but the following tables summarize their features at a glance.

Codec Features

CODEC	Mono / Stereo	Lower Bit Rates	Lower Delay	Remote Broadcasts	STL & Infrastructure	Error Concealment	Highly Compatible
AAC-ELD	M/S	✓	✓	✓		✓	
AAC-HE	M/S	✓		✓		✓	
AAC-LD	M/S		✓	✓		✓	
AAC	M/S				✓	✓	
Layer 2	M/S				✓		✓
G.722	M	✓	✓	✓			✓
G.711	M	✓	✓				✓
aptX® Enhanced	M/S		✓		✓		
PCM Linear	M/S		✓		✓		✓

Codec Characteristics

CODEC	Bit Rates	Audio Expectations	Typical Use
AAC-ELD	48 – 64 kbps	Excellent quality for low bitrates, full audio range, mono or stereo, low delay. Error concealment.	Live broadcasts of voice or music. Can use for music if necessary. Quick interaction with studio hosts and callers.
AAC-HE	16 – 96 kbps	Excellent quality for low bitrates for voice and music. Full audio range. Relatively high delay. Error concealment.	Music at lower bitrates. Best for one-way broadcasts where tight interaction with studio hosts or callers is not critical. Works at very low bitrates with some compromise in quality.
AAC-LD	112 – 320 kbps	Excellent, full-range audio quality for medium bitrates. Low delay. Error concealment.	Music or voice at medium bitrates. When medium bandwidth is available and interaction with studio hosts or callers is needed, this is a great choice.
AAC	80 – 320 kbps	Excellent, full-range audio quality for medium bitrates. Slightly higher delay. Error concealment.	Music at medium bitrates. For the medium range of bitrates, this is the best codec to choose when a little delay is okay. Quality is fully “awesome,” especially at 256 kbps and higher.
Layer 2	112 – 384 kbps	Excellent quality at medium-high bitrates. Very compatible with other brands of equipment.	Music or voice at medium bitrates to other brands of codecs. Layer 2 is a great choice, especially for compatibility across different brands of codecs.
G.722	64 kbps	Good voice quality (7 kHz) when low delay and compatibility is needed. Also called “HD Voice”	Voice at low bitrate to other brands of codecs. Not “high quality,” but much better than a standard telephone call. It’s the most compatible low bitrate codec with any other brand.
G.711	56 – 64 kbps	Low quality, low delay mono voice. Only 3.3 kHz audio	This is a “phone call.” Often used for compatibility for SIP (VoIP) calls to or from regular telephones.
aptX® Enhanced	384 – 576 kbps	Excellent quality, full audio bandwidth, low delay. Optional on some codecs.	aptX® Enhanced is primarily used in professional broadcast applications where low delay is desired and cascading coding algorithms may be encountered.
PCM Linear	1536 – 2304 kbps	Perfect quality, full bandwidth, low delay. No error concealment.	Perfect audio for perfect connections. If you’ve got the bandwidth and a perfect IP path (low jitter and no packet loss), this is the perfect “algorithm.” Bit rate is not variable, but is fixed for given mono/stereo and bit depth parameters.

3 Installation

3.1 Rack Mounting the Studio Unit

The Z/IP ONE mounts in a 1RU space in a standard 19" rack. The Z/IP ONE does not have an internal fan, and does not have any special requirements for space above and below the unit. As long as you keep the stirred air in the rack between 0 and 40 Celsius (32 to 104 degrees Fahrenheit) with a relative humidity of 0 to 98% (non-condensing), the unit will operate as described.

3.2 Power

Install the power cord included with the Z/IP ONE in the marked AC power connector located in the rear of the unit. The internal universal switching supply will accept 100-240 VAC (50-60 Hz) input. You should see the blue front panel LED flash to indicate the unit is booting. Subsequently, the main menu will appear. This process can take about 90 seconds.

3.3 Balanced Analog Inputs

Input Audio XLR Pinout

PIN	DESCRIPTION
1	Ground
2	Signal + Input
3	Signal - Input

Install the left and right analog audio cables in the female XLR connectors marked "CH 1 In" and "CH 2 In" on the rear panel. The analog audio section accepts audio input with a peak level of +22dBu. In the **Audio I/O -> Input** mode **Left** or **Right** menu option, each audio input can be configured for the following settings:

- ◆ Line (+4 dBu nominal)
- ◆ Microphone
- ◆ Mic + Phantom Power

Mic Gain Trim

There is a microphone gain trim adjustment option in the **Setup->Audio I/O** menu for each input, which can be used to add additional gain when that input is set to microphone level. This setting is ignored when an input is set to line level. Gain should be adjusted so that the microphone reaches your desired level on peaks.

3.4 Balanced Analog Outputs

Output Audio XLR Pinout

PIN	DESCRIPTION
1	Ground
2	Signal + Output
3	Signal - Output

The audio outputs are balanced to +4 dBu, with 18 dB of headroom (i.e., inputs clip at +22 dBu).

3.5 AES/EBU Input

Input Audio XLR Pinout

PIN	DESCRIPTION
1	Ground
2	Signal + Input
3	Signal - Input

3.6 AES/EBU Output

Output Audio XLR Pinout

PIN	DESCRIPTION
1	Ground
2	Signal + Output
3	Signal - Output

3.7 Network Interfaces

The Z/IP ONE is designed to work on managed private networks or the public Internet. For reliable operation when connected to the public network, the Z/IP ONE must be placed behind a firewall. These are commonly included in network address translating routers, commonly called either “NAT routers” or simply “routers.” The Z/IP ONE conjunction with the ZIP server on the public Internet, has technology for automatically creating connections without requiring port forwarding on most styles of NAT routers. For more information on these topics, see Chapter 9, *Audio Streams* and Appendix A, *When an IT Department is not Available*.

The network interfaces are Ethernet, twisted pair, 100BaseT connectors. Use a CAT5e or CAT6 network cable. The standard pin-out for an RJ45 style 8-Pin/8-Position miniature modular jack when used for 10/100BaseT Ethernet is:

PIN	FUNCTION
1	Transmit +
2	Transmit -
3	Receive +
4	Unused
5	Unused
6	Receive -
7	Unused
8	Unused

3.8 USB Ports

Attach any of the supported USB devices to these ports. Use of an unapproved device may cause unpredictable and unacceptable results. Therefore, we recommend against such experimentation. The pin-out of the standard USB connector used in the Z/IP ONE is:

PIN	FUNCTION
1	+5 Volts
2	Data -
3	Data +
4	Ground

3.9 Parallel Control

The DB25 connector on the back panel provides contact closures (close-to-ground) inputs and outputs. There are 8 open-collector outputs, and 8 open-collector inputs, each configurable from the Settings menu on the user interface. The DB 25 connector is pinned out as follows:

PIN	FUNCTION
1	+5 Volts DC 400 mA max
2	Output 0
3	Output 1
4	Output 2
5	Output 3
6	Output 4
7	Output 5
8	Output 6
9	Output 7
10	No Connection
11	No Connection
12	No Connection
13	No Connection
14	Input 0
15	Input 1
16	Input 2
17	Input 3
18	Input 4
19	Input 5
20	Input 6
21	Input 7
22	Not Connected
23	Not Connected
24	Not Connected
25	Ground

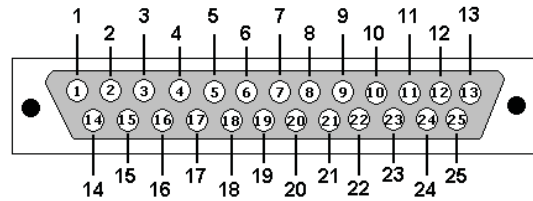

See Chapter 12 for more detailed information on the contact closure operations.

4 The Front Panel Interface

4.1 Front Panel Controls

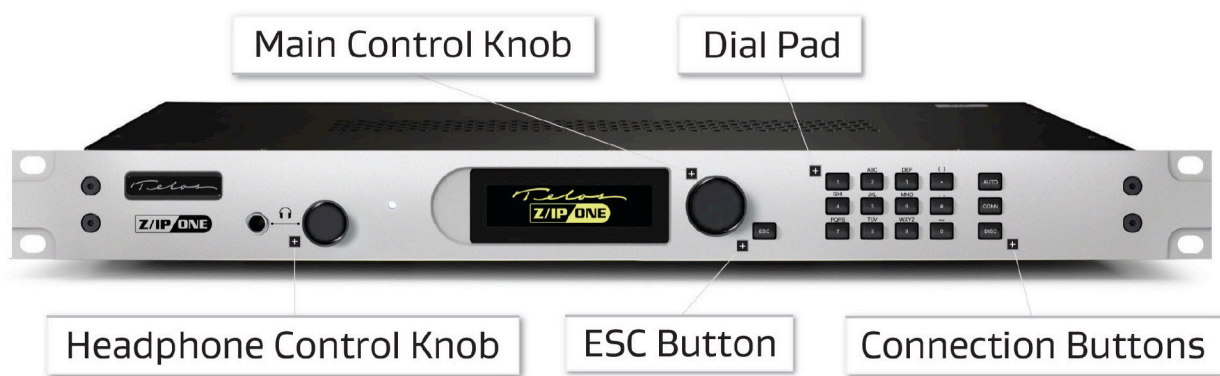

Headphone Control Knob

This is a volume control and monitor selection button. Turning the knob will change the headphone volume. Pushing this button will select between the receive audio and the transmit audio. Neither of these function will affect the audio on the main outputs. While changing the volume, the display will indicate which audio is present on the headphones.

Main Control Knob

Rotating the Z/IP ONE's control knob moves the cursor. It also has a push-to-click function. Pressing the knob selects the highlighted menu selection, or accepts the current value the setting that is being edited.

ESC Button

This button escapes from the currently selected menu or dialog screen. While editing a setting, pressing the ESC button cancels any edits and leaves the field unchanged. From the main menu screen, pressing ESC will take you to the status screens (and vice versa).

The Number Pad

The dial pad is used to enter data in edit fields. If the field accepts only numeric data (or IP addresses), then pressing the buttons will enter the number pressed.

Other fields accept alphanumeric strings. In these fields, the buttons cycle through the number, then the alphabetic characters in uppercase, and then in lowercase. The 1, 0, *, and # buttons allow you to enter special characters and punctuation.

	CHARACTERS ENTERED
1	1 : / @ ! = ^ \
2	2 A B C a b c
3	3 D E F d e f
4	4 G H I g h i
5	5 J K L j k l
6	6 M N O m n o
7	7 P Q R S p q r s
8	8 T U V t u v
9	9 W X Y Z w x y z
0	0 <space>
*	* () < > [] { }
#	# . , - _ % ? ; '

The Connection Buttons

On the right side of the front panel, the Z/IP ONE has three buttons (labeled AUTO, CONN, and DISC) for setting up and dismissing connections. The function of each of these keys is as follows:

- ◆ AUTO gives you quick access to your “phone book.” This screen displays the current status of other Z/IPs, so that you can see if they are available before you call. Pressing AUTO or the control knob while in the phone book will immediately dial the selected entry
- ◆ CONN takes you to a manual dialing screen on which you can enter the details of the codec you wish to call
- ◆ DISC is used to terminate connections. You will be prompted to confirm the disconnection. Pressing DISC again while on this screen or selecting the Yes button with the main control knob will end the call

4.2 The User Interface and Menu System

After a period of inactivity, the Z/IP ONE will time out to a status screen. Pressing the ESC button will exit to the menu system. Rotating the main control knob moves from option to option, while pressing it will select the currently highlighted item. While in a menu, pressing ESC will back you up one level. Repeated presses will take you to the main menu.

From the main menu, you can access the *Status*, *Phonebook*, *Audio I/O*, *Setup*, *Help*, and call *History* sub-menus.



Getting Help!

Context-sensitive help is available at any time by pressing the 1 button. General help can also be accessed by choosing *Help* from the main menu.

Clearing Pop-ups

When a condition exists that requires attention, the Z/IP ONE will display a pop-up box in front of whatever screen is otherwise active. To close the current pop-up, press the ESC key. To close all pop-ups in the stack, press the 0 key.

The Z/IP ONE keeps a list of all pop-up screens that have been displayed since the last time it was rebooted. This list is shown on the Logs web page.

5 The Audio I/O Menu

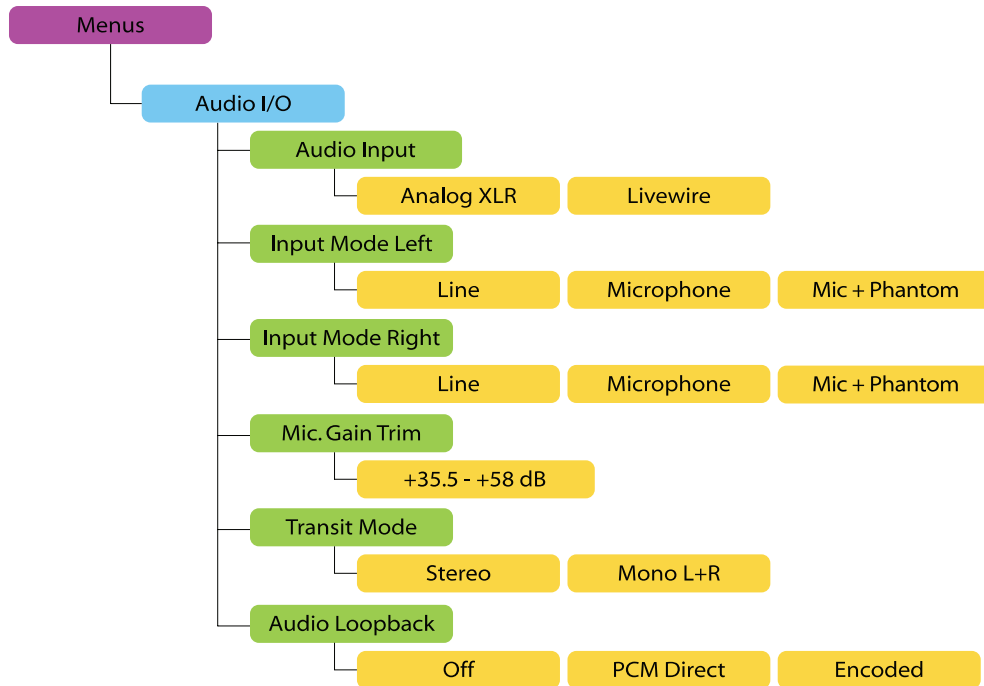

This menu gives access to the various settings related to audio into and out of the device.

5.1 Audio Input Source

The Audio Input Source item chooses which audio input is encoded and transmitted to a remote codec. You must choose between the Analog XLR, AES/EBU XLR, and Livewire for the input (transmit) audio.

If you decide to use the Livewire input, you will also need to choose a Livewire input stream in the Setup>Network>Livewire menu. Like the XLR outputs, the Livewire output is always active, provided that a Livewire source number is configured on the Livewire setup page. To disable Livewire outputs, set the Z/IP ONE's source number to 0.

In addition to selecting the audio source to transmit, this menu allows you to configure your Z/IP ONE for redundant audio inputs, to help protect against failures. To use this feature, select either the AES/EBU + failover or Livewire + failover option.

When using Livewire + failover, the Z/IP ONE will prefer Livewire audio if it is available. If it is not, for whatever reason, the Z/IP ONE will use the AES/EBU input for its transmit audio. If the AES/EBU stream is unavailable, it will use the Analog inputs. The Z/IP ONE will also revert back to a more preferred audio source when the problem is cleared and the preferred stream has been stable for some time.

When using the AES/EBU + failover option, the Z/IP ONE's behavior is as above, except it will never use Livewire for the audio input.

5.2 Input Mode

The **Input Mode Left** and **Input Mode Right** menus select the behavior of the Analog XLR inputs. You can choose between Line-level inputs, Microphone-level inputs, or mic-level inputs with 15V phantom power enabled. The exact gain of the input is dependent on the mode, and selected by items further down this menu.

5.3 Microphone-level Gain

Use the **Mic Gain Trim** setting to set the gain level of the analog XLR inputs. This only affects the inputs that are set to *Microphone*, but if both the left and the right inputs are microphones, they must both use the same gain level. The available microphone gain is from +23.5dB to +47.5dB in 1.5dB steps.

5.4 Line-level Gain

The **Line Gain Trim L** and **Line Gain Trim R** items set the gain of the respective analog XLR inputs. These settings only affect inputs that are set to *Line*. The left and right Line-level gains can be set independently, from -12dB to +12dB, in 1.5dB steps.

5.5 Transmit Mode

The Z/IP ONE can be configured to transmit stereo audio, or sum inputs to send a mono stream. The **Transmit Mode** setting affects all input types.

Some codecs only support stereo or mono operation. When using these codecs, the proper transmit mode is used automatically, so the transmit mode setting will never affect codec availability when configuring a call. However, be aware that in many codecs, changing the stereo mode does change the available range of bit rates. After changing the stereo mode, the codec setup page will automatically show the new bit rate range available for the selected codec.

For an 'at a glance' display of all codecs and how they are affected by the transmit mode, see the Audio configuration webpage.

5.6 AES/EBU Output Sample Rate

Use the **AES/EBU Output** setting to select the sample rate of the AES/EBU audio output by the Z/IP ONE. You can select between *48 kHz*, *44.1 kHz*, *32 kHz*, and *Sync to AES-Input*. All of the fixed sample rate settings are relative to the Z/IP ONE's internal sample clock. Use *Sync to AES-Input* if the device connected to the Z/IP ONE's AES outputs does not have its own sample rate converter, or to sync to a facility-wide clock. Regardless of the sample rate chosen, the encoded audio streams will always use 48kHz sample rate.

5.7 Loopback

The **Audio Loopback** setting is intended for local audio testing. When set to *PCM Direct*, the configured input will appear on all local outputs (analog XLR, AES/EBU XLR, headphone, and Livewire (if configured)) without any compression. When set to *Encoded*, the configured audio input will appear on all outputs after it has been encoded and decoded. When in loopback, the Z/IP ONE uses the maximum bitrate configured for the codec.

To stop looping audio, change the setting to *Off*. The Z/IP ONE will also automatically end the loop mode if the codec is rebooted or powered off.

6 The Setup Menu

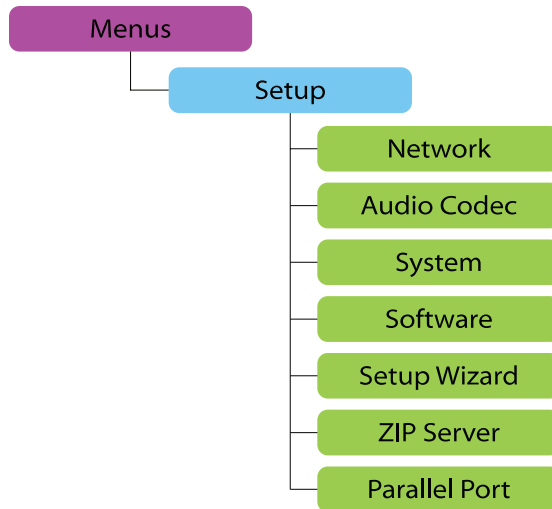

The Setup menu and its submenus contain items that are infrequently changed.

At the top level, the Streaming Interface menu item selects the Ethernet or other interface that will be used to communicate with another codec. In most cases, this will be the WAN interface. The options are:

- ◆ LAN Port
- ◆ WAN Port
- ◆ WiFi/WLAN (appropriate USB device must be installed)
- ◆ UMTS/EVDO (appropriate USB device must be installed)

6.1 Network

The WAN Interface menu sets the following options for the WAN RJ45 on the back panel:

- ◆ WAN DHCP – *Off* or *On*
- ◆ WAN IP Address – Only used when DHCP is off
- ◆ WAN subnet mask – Only used when DHCP is off
- ◆ WAN Gateway IP – Only used when DHCP is off
- ◆ WAN DNS Server IP – Only used when DHCP is off
- ◆ Activate Settings – Accepts the above settings and restarts the WAN interface

The LAN Interface menu sets the following options for the LAN RJ45 on the back panel:

- ◆ LAN DHCP – *Off* or *On*
- ◆ LAN IP Address – Only used when DHCP is off
- ◆ LAN subnet mask – Only used when DHCP is off
- ◆ LAN Gateway IP – Only used when DHCP is off
- ◆ LAN DNS Server IP – Only used when DHCP is off
- ◆ Activate Settings – Accepts the above settings and restarts the LAN interface

When changing any Ethernet port settings, even DHCP, you must select the Activate Settings item for the changes to take effect.

The Livewire menu has the following options:

- ◆ Select LW Input Stream – This list box shows the available Livewire streams on your network. After boot-up, it may take a minute before all available streams have been detected. Highlight the list and press the control knob to browse the streams. Press the knob again to select the highlighted stream as your Livewire audio input.
- ◆ LW Output Stream Number – Enter 0 to disable Livewire output. Enter a stream number in the range 1 – 32000 to generate a Livewire stream. Once configured, this stream will always be active, regardless of the chosen audio input.

To actually use the selected Livewire input stream as your audio input, you must also change your audio input device in the Audio I/O menu to *Livewire*.

The SIP Server submenu is only used if your organization uses a SIP server to make VoIP calls. Contact your SIP server administrator for the values to enter in these fields, or leave them blank not to use your own SIP server. N/ACIP SIP calls may also be made via “direct dial” to the remote codec’s IP address, without involving a SIP server.

- ◆ Registrar Hostname (allows entry of alphanumeric text)
- ◆ Registrar User Name (allows entry of alphanumeric text)
- ◆ Registrar Password (allows entry of alphanumeric text)
- ◆ Activate Settings – Accept the above settings and attempt to authenticate with the SIP server
- ◆ SIP Port – Set a custom TCP port to use for SIP, leave blank to use the default of 5060.

For more information on setting up and using SIP, see Section 9.2, *N/ACIP Session Initiation Protocol*.

The WiFi/WLAN menu has the following fields:

- ◆ Browse SSIDs... – This button brings up a screen displaying all broadcast network IDs detected by the Z/IP ONE. Selecting an SSID from the list will fill out the ESSID Network Name field for you.
- ◆ ESSID Network Name – enter this manually if your access point is not set to broadcast its SSID
- ◆ Encryption Method – choose the type of encryption used by your Wi-Fi access point. “String” refers to an alphanumeric password, while “Hexnum” refers to passwords that are limited to hexadecimal characters (digit values of 0-9 and A-F)
- ◆ Pwd String/ Hex Number – the password required by the encryption method
- ◆ Activate Settings – accept the above settings and attempt to authenticate with the Wi-Fi hotspot

UMTS/EVDO has the following settings:

- ◆ **Country** – *Germany, South Africa, USA, Provider ‘Orange’ or Use Dial Number*
- ◆ **Protocol** – *CDMA or GPRS*
- ◆ **Dial Number** – Allows entry of a numeric string
- ◆ **PIN Number** – Allows entry of a personal ID number
- ◆ **Account Name** – Alphanumeric text
- ◆ **Account Password** – Alphanumeric text
- ◆ **Provider URL** – Allows entry of a valid URL
- ◆ **Activate Settings** – Accept the above settings and attempt to authenticate with the wireless internet provider

Router Mode can be set either *Off* or *Between LAN and StreamIfc* (short for “streaming interface”). When **Router Mode** is *Off*, the Ethernet ports are kept completely separate. When it is enabled, the Z/IP ONE creates a bridge between the LAN and whichever interface is selected for streaming. You can use this to allow another device to access the network used by the streaming interface through the Z/IP ONE’s LAN port.

For example, consider a Z/IP ONE that is being configured to use a Wi-Fi hotspot. In order to use the access point, you must log in using a web page, but the Z/IP ONE cannot display web pages. To solve this problem, turn on Router Mode, and connect a laptop to the LAN port of the Z/IP ONE. Set the LAN interface on the Z/IP ONE and the laptop’s Ethernet controller to be on a private network together. Set the laptop’s gateway to the Z/IP ONE’s IP address. For example:

Z/IP ONE Settings

LAN IP Address	192.168.3.10
LAN Subnet Mask	255.255.255.0
Gateway	<leave blank>

Laptop Settings

LAN IP Address	192.168.3.11
LAN Subnet Mask	255.255.255.0
Gateway	192.168.3.10
DNS Server	8.8.8.8

Now, when you access the web on your laptop, the connection goes through the Z/IP ONE as though it were a router. You will see the Wi-Fi hotspot’s login page. After you log in with your laptop, the Z/IP ONE will be able to use the hotspot to connect to the Z/IP Server and any other Zephyr/IP.

You can use this any time you have only one network connection that you need to share between the Z/IP ONE and other equipment.

RTP Push Receive Port – Change the RTP receive port from the default of UDP 9150, or make blank disable. The three fields following this, **G.722 reply at (port+1)**, **Rcv codec reply at (port+2)**, and **User codec reply at (port+3)** are for configuring an automatic reply to an incoming RTP stream. For a full explanation of how these settings are used, see Section 9.3, *Real-time Transport Protocol*.

Multicast TTL – TTL stands for “Time to Live.” It is a value in every IP packet sent that is decremented every time the packet passes through a router. When the number hits zero, the router won’t pass it any further. It is a tool that is useful in restricting how far in a network information is allowed to go. Although the Z/IP ONE cannot subscribe to multicast stream of compressed audio, it can send an encoded RTP stream to a multicast address. This can be used to let the switches and routers in a managed network replicate the Z/IP ONE’s stream to many receivers. By default, multicast packets have a TTL of 1, which means they cannot be routed.

If your managed network requires multiple hops for multicast traffic, you can customize the time to live here.

HTTP/Web Server Port Allows you to change the Z/IP ONE’s management web interface. Entering a 0 in this field uses the standard, port 80. Since the standard port (and the unofficial, but relatively common management ports of 8800 and 8080) are well known, a Z/IP ONE on the public internet should have its web server set to a unique, non-standard port.

This can also be used to allow management of multiple Z/IP ONEs that are behind a router that supports port forwarding, but not port translation.

6.2 Audio Codec

The **Audio Codec** menus allow the user to change various settings related to the audio and transmission quality, and also to select the appropriate compression scheme. For more detailed information on audio encoding and the codecs used in the Z/IP ONE, see Appendix B.

As you change the profile, the other settings on this screen are updated to show what will be used by that profile. All preset profiles use AAC-ELD between 8kbps and 64 kbps. They differ in the minimum and maximum buffer settings.

If you select *User Setting* for your profile, the options you choose below are used. Changing any of these options when you are on a preset profile will change the profile to *User Setting* automatically.

If you set the bitrate minimum to be the same as the bitrate maximum, and also set the buffering minimum to the same as the buffering maximum, the Agile Connection Technology (ACT) algorithm will be disabled, even for codecs which support ACT.

- ◆ **Encoding Mode** selects how the Z/IP ONE encodes the audio that it sends to the remote codec. Different codecs support different features and bit rates. Changing encoders will change the range of the rates that can be selected under **Bitrate Minimum** and **Bitrate Maximum**.

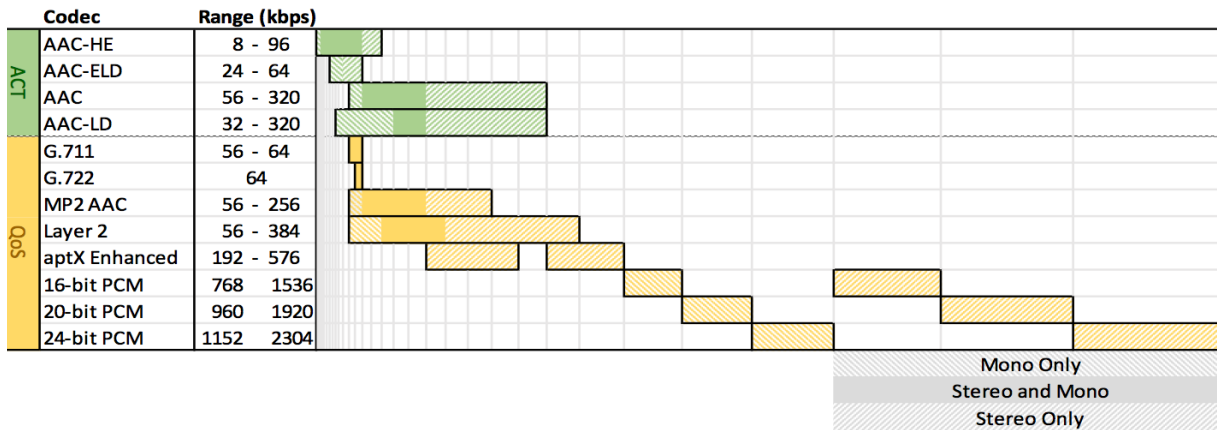

The codecs in the Z/IP ONE can be put into two broad categories: ACT-capable, and QoS-required. Codecs which support ACT can change bit rate and buffering in response to network conditions. The codecs we refer to as ‘QoS codecs’ should only be used on network links with guaranteed quality of service, since their bit rates and buffer depth cannot be changed after the connection is established. The encoders which support ACT are AAC, AAC-LD, AAC-ELD, and AAC-HE.

The *aptX Enhanced* codec is available as an optional software license. To use aptX, each Z/IP ONE must have a license to use the codec. If you would like to evaluate the codec before purchasing it, a demonstration mode is available. Z/IP ONEs without an aptX license will can use the aptX codec for five minutes. At the end of five minutes, the call will be automatically disconnected. You may preview the codec again after a reboot. The *aptX Enhanced* codec is available as an optional software license. To use aptX, each Z/IP ONE must have a license to use the codec. If you would like to evaluate the codec before purchasing it, a demonstration mode is available. Z/IP ONEs without an aptX license will can use the aptX codec for five minutes. At the end of five minutes, the call will be automatically disconnected. You may preview the codec again after a reboot.

- ◆ **Bitrate Maximum and Bitrate Minimum** – these parameters allow you to set limits on the range of bitrates available to the Z/IP ONE’s Agile Connection Technology (ACT) intelligence when adjusting for various network defects. The wider the range, the greater the flexibility of the encoder to ‘fine tune’ your connection and audio fidelity. Your choice of codec will affect the available range of usable rates. The more you restrict this range, the more consistent the audio quality will be, but with less ability to accommodate bad network conditions. For codecs which do not support ACT, the maximum bitrate is always used.
- ◆ **Maximum Buffer and Minimum Buffer** – these two numbers specify the minimum and maximum decoder buffering. For optimum performance, you should set these to 0ms and Unlimited. Note that if you change the buffering while a call is in progress, you will be notified that the changes will only take effect after the call is reconnected. Furthermore, the buffering only applies to MPEG codec modes, but not to G.711, G.722, or PCM. For codecs which do not support ACT, the maximum buffer setting is used. The total delay in a transmission will be the algorithmic delay of the codec mode used, plus the current buffer setting (as determined by these values and the Z/IP ONE’s ACT intelligence).
- ◆ **Layer-2 Payload Type** is used with Real-time Transport Protocol (RTP) audio streams and the MPEG Layer 2 codec. While many players support the dynamic payload type (96), some require that the payload is set to MPEG Audio (14). Leave this setting on 96 – *Default* unless you are having trouble with this exact scenario.

Please note that the original Zephyr/IP and Z/IP ONEs prior to software version 1.5.0r will only recognize Layer 2 streams using the default, payload type 96. If you attempt to connect to one of these codecs with a Layer 2 stream using payload type 14, the stream will not be decoded by the older codec. The call will end as an ‘unclean’ disconnect, since receiver considers the received packets malformed. Due to this, the Z/IP ONE will display a message informing the user of a network transmission failure.

6.3 System

The Setup->System submenu contains settings for general system options.

- ◆ **Autoanswer** – if auto answer is turned *On*, the Z/IP ONE will accept any incoming connection. Otherwise, the user will be prompted to accept or reject all incoming calls.
- ◆ **Display Contrast** – sets the brightness of the screen. Turning the contrast down will extend the life of the display
- ◆ **Frontpanel Speaker** – choose which sounds are played during operation, or disable the internal speaker. *Keyboard Clicks* are short beeps in response to pressing buttons or turning the control knob. *Sounds* are other beeps or beep sequences that provide status (for example, an incoming ring, or a successful connection).
- ◆ **Redial Mode** – if an outgoing call fails abnormally, this setting determines whether the Z/IP ONE attempts to reestablish the call, and if so, how many attempts to make.
- ◆ **Display Dim Timeout** – Enables a ‘screensaver’ that turns the contrast very low until any key or knob is used. Use this to extend the life of the display if the Z/IP ONE is not monitored via the front panel.
- ◆ **Remote ctrl password** – this is the password used to access the Z/IP ONE’s configuration
- ◆ **NTP Server** – Specifies a network time protocol server to use to set the time and date on the Z/IP ONE. Time and date are used on status displays and for time stamping pop-up messages and troubleshooting logs.
- ◆ **Timezone, hours East** – specifies how many hours east of UTC 0 your time zone is. This is used to calculate the correct time to show on logs and status screens.
- ◆ **Default Status Page** – chooses one of the main status displays to show when there is no front panel activity. See Chapter 7 for more information on the status displays.

6.4 Software

The Setup->Software submenu allows you to choose between two different installed versions of the Z/IP ONE’s software. The last option, Reset to Defaults and Reboot, will erase all custom settings and phone book entries. When the Z/IP ONE reboots, it will have the same settings it had when it originally came from Telos. It is a good idea to back up your Z/IP ONE’s settings before resetting to factory defaults.

While you can use the front panel interface to select which installed version of software to run, you can only install new software via the internal webserver. See Chapter 8 for more information on installing and managing software versions, as well as backing up your Z/IP ONE’s settings.

The Software submenu also has a field for entering the software license key used to activate the aptX Enhanced codec. If your Z/IP ONE has a path to the Internet, you can use the front panel enter the activation key. The Z/IP ONE will contact the license server, and activate the software.

You may also enter the activation key via the Software web page. If your Z/IP ONE is on a private network, this is the method that you must use. When you enter the key on the web page, if the Z/IP ONE is unable to activate the key on the license server, you will be given a link to activate the key yourself. The license server will respond with an activation code, which you will also enter on the Software web page.

For more information on installing aptX or to order a license, contact Telos Customer Support or your local Telos dealer.

6.5 Setup Wizard

The Setup Wizard offers a guided approach to setting the most commonly used network settings. It appears the first time the Setup menu is accessed, and can be run again by selecting this menu item.

For an overview of the Setup Wizard, see Chapter 2, *Quick Start Guide*.

6.6 ZIP Server

The Setup->ZIP Server menu allows the user to select which ZIP Server to use, and how the Z/IP ONE is represented on that server. This section has a brief description of how each of these settings is used. For a more thorough discussion, see Section 9.1, *Telos Session Control Protocol*.

- ◆ **Device/Unit name** – use the keypad to enter a unique name for your Z/IP ONE. You will share this name with your peers so that they can see your online status and call you. Don't worry – if you pick a name that another user has already chosen, the ZIP Server will append a number to your name and display it accordingly.
- ◆ **Group name** – Use this field to register with a particular group that has been created on the ZIP Server. The default is “public,” which allows your Z/IP ONE to be contacted by anyone in the network. If you have created a private group on the server, enter its name here
- ◆ **Group password** – the default is “public” for the public group. If you are registering with a private group, enter its password here.
- ◆ **Device Visibility** – Choose whether the Z/IP ONE is visible to everyone in the directory, only people in the same group, or no one at all. A ‘hidden’ Z/IP ONE can still be dialed by anyone who knows its name and group, but will not show up in any directory listings.
- ◆ **ZIP Server Name** – Use this field to enter the name of the ZIP Server you will be connecting to. Telos maintains a server at zip.telos-systems.com, which is the default. This field is provided just in case that address ever needs to change.
- ◆ **Listen Port** – Enter a value in this field if you need to set a particular port on your Ethernet router to allow Z/IP communications through. The default is ‘0,’ which instructs the Z/IP to use a random port for listening. This random port is shared with the Z/IP Directory Server, which maintains a list of which ports are used by which Zephyr/IPs. This is most useful when setting up port forwarding through a restrictive NAT. If the Z/IP ONE reports a symmetrical NAT, contact your IT administrator for advice on what setting to use here and to set up a port forward.
- ◆ **Create a Group** – Select this option to go to the Group Creation screen. Here, you will enter the desired name for your group, the group password that users will enter to join and search the group, and the administration password for the group.

For studio units, we recommend setting up port forwarding in the gateway router. This is not mandatory, but it will help ensure best performance. To do this, you must specify a Listen Port, above. Check with your IT administrator for more information.

6.7 Parallel Port

The Setup->Parallel Port submenu shows the settings and current state of the input and output General Purpose I/O (GPIO) pins. These pins may be either on the physical parallel port on the back of the Z/IP ONE, or virtual pins on Livewire GPIO. Output status bits are always reflected both on the physical and virtual ports, but you must configure which of these two sources is used for the input bits.

- ◆ **Input Bit 1-8** – Sets the Z/IP ONE's response to toggling an input pin.
- ◆ **Output Bit 1-8** – Sets what status information is reflected on each of the output pins.
- ◆ **Bit 0-3 GPO** – the Z/IP ONE's eight GPIO signals can be on the parallel port, or over Livewire. Since Livewire GPIO comes in bundles of five inputs and five outputs, the Z/IP ONE uses the first four pins of two separate Livewire GPIO addresses. If a GPO source is specified here, the first four inputs are taken from this Livewire GPIO port. Livewire GPI outputs are always present.
- ◆ **Bit 4-7 GPO** – The Livewire GPO source bits for inputs four through seven. Leave this field blank to use the parallel port for GPIO inputs.

More information on parallel port operation can be found in Chapter 12, *Ancillary Data2, Ancillary Data*.

7 The Status Screens

The Z/IP ONE has seven screens of information reporting the current state of different systems in the codec. You can reach these displays from the main menu by either selecting the Status item or pressing the ESC key on the keypad. A status screen will also be shown when there is no user activity on the front panel interface.



When status is displayed, you can cycle through screens by turning the main control knob. Return to the main menu by pressing the ESC key.

The section titles in this chapter match the labels used in the *Setup->System->Default Status Page* menu item, for ease in selecting a default.

7.1 Overview



The first screen displays broad information on a number of systems. At the top of the display are level meters for the transmitted and received (decoded) audio. The left channel is at the top, with the right channel under it. To the left of the meters is an indicator of what audio input is currently being used. This is especially useful when input failover is enabled. The icons have the following meanings:

-  Analog XLR
-  AES/EBU XLR
-  Livewire

Beneath the meters are items reminiscent of illuminated indicators. A filled (lit) circle indicates a normal operating condition:

- ◆ Connect – shows whether the Z/IP ONE is currently connected to any other codec
- ◆ LAN / WAN – indicates Ethernet LINK status
- ◆ ZIP – When lit, the Z/IP ONE is logged into the ZIP Server
- ◆ RcvLock – When the decoder is locked, this indicator lights. This is useful for troubleshooting:
 - ◇ RcvLock, but no Connect: Local loop mode is on. Disable it in the Audio I/O menu
 - ◇ RcvLock and Connect, but no Rcv meters: Silence is decoded. Check audio Xmt meters on remote unit
 - ◇ Connect but no RcvLock: Network conditions make the encoded audio unusable (too much loss, a firewall blocks packets, frames corrupted in transit, etc)
- ◆ Livewire – the LAN interface has available Livewire streams
- ◆ LW Sync – The Z/IP ONE's Livewire clock has synchronized with the time base of the Livewire network on the LAN interface

At the bottom of this screen are quality and buffer indicators. The Rcv meters indicate the fullness of the received audio buffer and the quality of the connection. Quality is measured using a combination of packet loss, latency, and jitter (time between packets) measurements.

The Far Buffer meter shows the fullness of the received audio buffer of the Z/IP ONE on the far end of the connection, and Xmt quality shows that unit's measurement of the stability of the connection. These two meters are not calculated by this Z/IP ONE, but are included in the information sent back from the remote unit. As such, they will only be present when the other end of the connection is a Z/IP ONE, and a connection method is used that supports the sending of additional information. When remote status information is unavailable, these meters will be shown in a darker, 'grayed out' color.

7.2 Call Status + GPIO

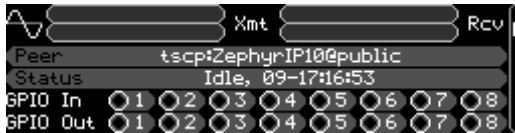

The second status page has information most useful during the production of a show. The same level meters and input source icon are shown on the top of the page for confidence monitoring. The middle section now has information on the connection progress (if any). The *Peer* line lists the current or last connection, and its type. The *Status* line has the current call status, and a timestamp of when the status last changed. In this case, the unit has been idle since the 9th of the month at about 17:17. This is the time that the call with *ZephyrIP10@public* ended.

The last two rows are GPIO information. They work with indicator 'lights' as on the first status screen. The meaning of each of the in and out bits is configurable on the *Setup->Parallel Port Configuration* page. The indicators are active (filled, or 'lit') when the associated GPIO bit is also active – 'asserted' or logically true. See Chapter 12, *Ancillary Data* for more information on GPIO operation.

7.3 Call Status + Codec

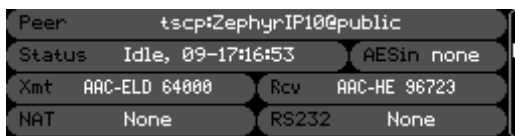

The information on this screen again relates mostly to a call in progress. The peer and status lines at the top have the same information as those fields on the page before. Following those, the Xmt and Rcv fields show the codec used and the current bit rate. For the Xmt field, the bit rate shown is nominal. For the Rcv field, the bit rate is actual – the Agile Connection Technology, if applicable for the current codec, will change the bit rate up and down to manage the buffer level.

The AESin field shows the sample rate of the AES input. The AES stream format has a field that can be used to indicate what the sample rate is. The Z/IP ONE measures the actual sample rate of the audio portion of the AES stream, and always displays that number. If the indicated sample rate does not match the actual sample rate, a question mark (?) is shown after the detected actual sample rate.

The NAT field will have some information on the type of Network Address Translation used by the router or routers between the Z/IP ONE and the ZIP Server or remote Z/IP ONE. What is most important about these types is that if both Z/IP ONEs report *Symmetric*, they will not be able to contact each other directly with a TSCP call. Instead, their audio will each be relayed over the ZIP Server to the other unit. This adds network hops, latency, and jitter, and should only be used as a last resort. However, if only one side has a symmetric NAT, the call can proceed as normal in most cases.

If your NAT is normally symmetric, you can set up port forwarding to your Z/IP ONE. When this is working properly, your NAT type should change to something else – most commonly “Port Restricted.” See Appendix A, *When an IT Department is not Available* for more information on setting up port forwarding.

The last field on this page is labeled RS232. Using a USB-to-Serial adapter (available as an accessory), you can send serial data alongside encoded audio. The remote Z/IP ONE will also require a USB-to-serial adapter to recover the serial data. This can be used to transmit automation system controls or other information that requires more than a contact closure.

7.4 Network Interface Status Screens

LAN - DHCP		UP & RUNNING	
IP	172.16.1.16	GW	172.16.0.1
Mask	255.255.0.0	MAC	00.13.95.06.DD.D0
IPv6			

This section covers the next four screens because, other than the port they refer to, the information presented is identical. In the *Default Status Page* menu item, these are referred to as LAN Info, WAN Info, WiFi/WLAN Info, and EVDO/UMTS Info, respectively.

The first field has the name of the interface that the page refers to. It also shows whether that port is using DHCP to get its settings automatically, or if they are set statically. Lastly, the first field is highlighted for the primary streaming interface.

At the top right, the interface status is displayed. This can be one of the following:

- ◆ UP & RUNNING – the interface is fully configured, the link is active, and there are no configuration problems that can be determined automatically
- ◆ No Cable – the link is down
- ◆ No DHCP yet – the interface is configured to use DHCP, and the link is up, but there has not yet been a response from a DHCP server
- ◆ No Gateway! – The gateway field is empty. The Z/IP ONE will only connect to other codecs on the same subnet
- ◆ GW unreachable! – The gateway field is filled, but the address entered is not on the same subnet as the Z/IP ONE
- ◆ Multiple GWs! – The gateway field is filled, but is the same as the gateway field on another network interface. This is a misconfiguration – any interface that has a gateway assigned must have a unique address entered.
- ◆ Invalid IP! – The IP address is filled, but is not valid
- ◆ Not Present – For WiFi and EVDO/UMTS, this means that the USB adapter that enables this interface is either not installed, or not working
- ◆ Configuring... - For WiFi and EVDO/UMTS, this means that the USB adapter that enables this interface has recently been installed, and is currently being configured for use

Following these status lines are the settings currently used by this network interface on the Z/IP ONE.

7.5 Version Info



Name	ZIPONE_78@public
Version	V1.9.10a 2014-01-09
Hardware	AES/EBU 02/01/3D/01 hex
S/N	APTX Not licensed

The last screen, **Version Info**, displays information about the hardware and the current software version. It also shows whether or not the aptX codec is licensed. Our customer service personnel may ask for the information on this screen to assist in troubleshooting your Z/IP ONE.

Older Z/IP ONEs, like the one shown, may not indicate a serial number. This is expected.

8 The Web Interface

From any web browser on your network, you can access the internal web pages of the Z/IP ONE. Simply open the browser window and type the IP address of your Z/IP ONE into the location bar. The main status page can be viewed without a login, but for any other link, you will be prompted to enter a user name and password. The default user name is “user” (case sensitive, without quotes), and there is no default password (just leave the password field blank).

You can always check or change the web password from the **Settings->System** menu of the Z/IP ONE’s front panel. You can also change the web server’s port via the front panel. If that is changed, you will need to browse to the web interface using the Z/IP ONE’s IP address, followed by a colon (:), followed by the new port number.

For example, if your Z/IP ONE is at address 192.168.1.140 and the HTTP port is set to 8810, you would enter its address in your web browser as `http://192.168.1.140:8810`

From the Z/IP ONE web interface, you can configure all of the options that are available on the front panel, plus a few that are not. The advantage of the web interface is that your monitor is much larger than the Z/IP ONE’s display, and you can use your mouse and keyboard instead of the control knob and dial pad.

8.1 Status Page

Z/IP ONE 1111_3 : Status

Connect Status
Audio Streaming
Network GPIO
System Software
Quick Start
User Manual
Logs
V1.8.10b

Connection Status		System Info	
Connection Status:	Connected	CPU Temperature:	34°C / 93°F
Connection Peer:	tscp.ZephyrIP10@public	Uptime:	0-05:23:29
Connected for:	0-00:00:11	Current time:	2013-10-02 19:57:09 UTC
		RS232 Adapter:	Not installed
	Receive	Audio / Livewire	
Total frames:	192	Transmit	384
Buffered frames:	47	Audio Output Level:	-34~-34 dB
Minimum buffer (frames):	47	Audio Input Level:	-48~-53 dB
Lost frames:	0	Livewire Clock:	None
Concealed frames:	46		
Dropped frames:	0		
Bitrate (bit/sec):	96909		
Samplerate (Hz):	48000		
Audio channels:	2		
Coding Mode:	AAC-HE AAC-ELD		

Network Interface Status				
	LAN	WAN	Wifi/WLAN	EVDO/UMTS
IP Address:	172.16.1.140	0.0.0.0	0.0.0.0	0.0.0.0
Network Mask:	255.255.0.0	0.0.0.0	0.0.0.0	0.0.0.0
Gateway IP:	172.16.0.1	0.0.0.0	0.0.0.0	0.0.0.0
MAC address:	00.90.FB.3C.7C.8C	92.95.55.05.A6.52	00.00.00.00.00.00	00.00.00.00.00.00
DHCP enabled:	yes	yes	yes	yes
Status	UP & RUNNING	No cable connected	Not present	Not present

Audio Meters

Send

Recv

The status page shows a summary of the Z/IP ONE’s connection statistics in more detail than the front panel display. Here, you can find detailed operating statistics and a summary of all four network interfaces’ settings. Unlike all the other pages, the status webpage does not require a login to view.

8.2 Connect

The Connect screen is a Java application. It has four tabs with controls to make and monitor calls, as well as manage the Z/IP ONE's phone book.

The Auto tab of the Java application is to use and manage your Z/IP ONE's phone book. The list of devices saved is on the right. The colors denote online status, as reported by the ZIP Server:

- ◆ Green – online
- ◆ Red – offline, or not found
- ◆ Blue – unknown. This is the color used by connections that do not use the ZIP Server (SIP, RTP, etc).

The remaining buttons on the Auto tab are used in the same way as their front panel equivalents. When you start a connection from this tab, you will be taken to the Status tab automatically. See Chapters 9 and 10 for more information on making connections and using the ZIP Server.

The Connect tab works similarly to the CONN key on the front panel. Here, you can manually enter information to dial other codecs.

Use the Direct Dial line to specify the connection protocol and address information:

- ◆ TSCP via ZIP Server: device@group
- ◆ TSCP via ZIP Server: tscp:device@group
- ◆ TSCP direct: tscp:ww.xx.yy.zz
- ◆ SIP via server: sip:localuser
- ◆ SIP via server: sip:remote@host.tld
- ◆ SIP direct: sip:ww.xx.yy.zz
- ◆ RTP direct: rtp:ww.xx.yy.zz

Below the Direct Dial line is a list of any connections that have been made since loading the Autodial application. You can save items from this list to the phone book. Starting a connection from this tab will take you to the status tab automatically.

The Status tab shows information about the connection currently in progress. The four items listed at the bottom are:

- ◆ Lost – Expected packets that never arrived, since the beginning of this connection
- ◆ Concealed – Audio frames that were concealed by the decoder, since the beginning of the connection. A number of frames will be concealed at the start of a call, before coded audio packets start to arrive. This is normal.
- ◆ Buffered – the number of frames currently in the decoder's buffer
- ◆ Dropped – frames that arrived, but were dropped without being decoded. This can be due to a burst of traffic that would otherwise overflow the buffer, frames that arrived too late to be decoded, etc.

The change in these values is graphed over time in the scrolling graphs. If you press the Disconnect button, the current connection will end, and you will be returned to the Auto tab.

Audio Metering shows the current transmit and receive meters.

8.3 Audio, Streaming, GPIO, and System

The options for these pages behave the same as their front panel equivalents. Please see Chapters 5 and 6 for a full discussion of these options.

The Codec page has some enhancements over the front panel menu. Each codec is shown side by side with all available bit rate changes shown. You can also see in real time how changing the encoding mode between mono and stereo affects the bit rate.

8.4 Network

This menu allows you to enter all of the network settings for your device. This can be useful (once you have entered the IP address in the front panel user interface of the unit), as many of the parameters are easier to enter using a keyboard than through the numeric keypad on the front panel. Keep in mind that if you change the IP address of your unit through the web page, you will need to reconnect to the device using the new IP address!

For help in troubleshooting your network configuration, there is a form at the bottom of the page labeled “Ping” – if you enter an IP address into this field and click the Ping button, the Z/IP ONE will send ten ICMP ping requests to the address you entered, and tell you how many responses were received.

In addition to the network interfaces, the ZIP Server, and SIP server settings are configured here. All of these settings are used and configured in the same way as they are on the front panel. For more information, see Section 6.1, *Network*.

8.5 Software Management

This menu allows you to update the software contained in the Z/IP ONE, to back up and restore its settings, and to enter an aptX license key.

The Z/IP ONE stores two ‘banks’ of software. Using this, you may, for example, test a new version of software while retaining the qualified version. You may choose which bank of software is current by selecting the appropriate bank and pressing the Reboot button.

You may only load software into the secondary bank. After you load the new software, you can continue running out of the primary bank, or reboot into the secondary to try the new software. When satisfied, you may then ‘commit’ that version to move it to the primary bank. Alternately, you may reboot back into the previous software, still stored in the primary bank.

To upgrade your Z/IP ONE, download the update package file from the Telos support web site at <http://www.telos-systems.com/codecs/zip-one/>. Do not extract this archive. Simply save it to a folder on your computer. Use the Choose File button on the Software Management web page to locate the package and select it. Click the Upload button to load the new software into the second bank.

Below the Software Update box is a section for configuration management and backup. The Backup Settings button will collect all the Z/IP ONE’s current settings into a file and download that to your computer via your web browser. To restore these settings, choose which categories you would like to restore, find the settings backup file using the Choose File button, and then load them into the Z/IP ONE by clicking Restore Settings.

The settings categories are for your convenience in sharing settings between multiple Z/IP ONEs. For example, if you have three codecs in different rooms, but that all call the same places, you may wish to restore only the phone book and system configuration. If you were to restore all the settings, their IP addresses on the network would conflict and would need to be changed again manually.

The category checkboxes are only used during a restore. All settings are always backed up in the file that you save on your PC. Use a full settings backup and restore to test new configurations, before lending to a different location, etc.

As an alternative to manual software updating and configuration management, the Z/IP ONE is fully compatible with the Axia iProbe network management software.

8.6 Quick Start and Manual

This link opens a PDF copy of the Quick Start guide (Chapter 2 in this manual) , or the whole manual, in your browser window.

8.7 Logs

Where the status page is focused on regular usage statistics, the Logs page displays usage history for the current session. It will show major operating events (such as connecting and disconnecting) , and has a history of all the messages that have been displayed in 'pop-up' windows on the front panel, and includes a screen shot of the current front panel display. Lastly, it has a link to a set of downloadable logs from the Z/IP ONE's internal processes. Telos' support team may request these logs from you to assist in troubleshooting.

9 Audio Streams

The main job of the Z/IP ONE is to make high quality audio connections with other units in remote locations, usually over the Internet. Moving audio through the Internet is not always simple, but the Z/IP ONE includes tools to help make it easier. To that end, your Z/IP ONE supports three different types of connections.

9.1 Telos Session Control Protocol (TSCP)

The primary method that the Z/IP ONE uses to connect to other Zephyr/IP codecs is called Telos Session Control Protocol, or TSCP. The primary features of this protocol are:

- ◆ Server authentication (optional):
 - ◇ Directory service
 - ◇ Presence service
 - ◇ NAT traversal
 - ◇ Media relay
- ◆ Bidirectional audio transfer
- ◆ Agile Connection Technology (on applicable codecs)

TSCP is a connection protocol. It sets up the connection between two Zephyr/IPs, but does not transport the audio. For that, RTP (Real-time Transport Protocol) is used. TSCP is the method used by two Zephyr/IPs to discover where they should each send their RTP streams.

The ZIP Server

TSCP connections can be made with or without the assistance of a directory server. They are point-to-point connections that transfer audio in both directions. Like all the Z/IP ONE's connection modes, TSCP allows you to use different codecs and bit rates in each direction.

A server is configured and maintained by Telos Systems as a service to our Zephyr/IP customers. It provides a set of tools to enhance the functionality of your Z/IP ONE: a directory, presence service, NAT traversal, and a media relay service.

Directory Service

The directory service allows your Z/IP ONE to register itself in a group, with a unique device name. The group and device name together form a persistent "phone number" for your Z/IP. Other users can always find and call your Z/IP ONE regardless of what IP address you happen to be using that day. This is especially important when your ISP has given you a dynamic IP address, or when you take your Z/IP ONE on the road.

The directory service also allows you to locate other Zephyr/IPs by browsing the server directory right from your Z/IP ONE. Wildcard and Soundex (phonetic) searches allow you to find the device you're interested in even if you don't remember the exact spelling of the other device's name or group.

Of course, you are in complete control over how your Z/IP ONE appears in the directory. You may list your Z/IP ONE as visible to all, or hidden. While in hidden mode, your Z/IP ONE does not appear in the directory, but it is still reachable by people that know your codec's name and group. Think of it as having an unlisted phone number – anyone who knows your number can still call you, you're just not listed in the phone book.

Groups

Groups are useful because they allow you to keep your Z/IP ONEs listed together. They make it easier for others to find you, and simplify the task of selecting a name for the device. A device name needs to be unique only within your group; it does not have to be unique among all the other Z/IPs in the world. We've all been frustrated when trying to select a login name, only to find that the most obvious names have already been taken by others!

Every Z/IP ONE is initially configured to be a member of the "public" group. This is a special group that exists by default on the server. Everyone has access to it (the group password is also "public"). It will always be there, and will never be deleted. When you first connect to the server, your Z/IP ONE will join the public group. You may use any device name you like, but if the name is already in use the server will assign you a unique name. You can then keep this, choose another, or join a group.

Groups can be created at any time, and you may create as many groups as you need. Groups are created by going to the **Setup->ZIP Server** configuration on the Setup menu of the front panel. A dialog will prompt you for the desired group name, group password, and administrative password. The group password is needed to either join or browse the group. You should give your group password to people that you want to have as members of your group. Those outside your organization should use the public group, or their own groups. The administrative password is used to change the group passwords later if needed, and should never be given to anyone.

Click the **Create Group** button to create the group. A message will indicate if the operation succeeded or failed. If the group creation failed due to a duplicate name, you will need to change the name and try again. Using the name of your organization, possibly followed by the city name for a large organization, may be more likely to succeed.

Groups remain active on the server as long as they have at least one Z/IP ONE that belongs to that group. If a group has no members, the server will delete the group after 24 hours.

Device Names

The server does not allow two Zephyr/IP devices in the same group to use the same device name. If you choose a name already in use in the *public* group, the server will append a number to the end of the name you selected. You can either keep this new name, or try again. Custom groups are different, see below.

Names remain valid on the ZIP Server for six months. During this time, your name is protected, so that someone cannot take it while your Z/IP ONE is offline. After six months of inactivity, the name is removed from the server directory. In most cases, this is not a problem: even if the name was removed from the server, when your Z/IP ONE connects again it can reuse its own name so long as no other device has taken it in the meantime.

If there is a time when you need to use the same device name on a different Z/IP ONE, you can reassign the name – but only if you are using your own group. In this case, simply join the group, and then configure the new Zephyr/IP with the same name as the old device. You will get a warning telling you that the name has been previously used by another device, and given a choice to select another name or take over this name. Since no two devices can have the same name at the same time, you should make sure there is no other device connected to the server that is using the same name. Please use this feature cautiously! Taking over the name of a unit that is currently online could cause the units to fight over the name, potentially resulting in a loss of service to both Zephyr/IPs.

Presence Service

Once your Z/IP ONE is registered with the server, it checks in periodically to make sure that the server knows about any IP address or other network changes that may have happened. Because of this, the server can keep track of which Zephyr/IPs are currently online. The presence service allows you to see the state of the other Zephyr/IPs in your phone book (or speed dial) list. This way, you can know if the Zephyr/IP you want to call is online before you even dial.

The state information is updated a few times per minute to always keep the list up to date.

NAT Traversal

Many networks make use of network address translation (NAT) devices to get around the shortage of public IP addresses (or even just to make devices less visible to the public Internet). In this case, the router will have the public, or WAN, IP address that is accessible from the Internet. Devices on the local LAN have what are referred to as 'non routable' IP addresses that are intended for local use only – generally in the 192.168.x.y or 10.x.y.z subnets.

NATs can be very useful, but they also make it difficult to reach devices that are behind the NAT. The ZIP Server allows your device to detect when it is installed behind a NAT, and also what type of NAT is in use. This helps allow the units to reach each other, even when both sides are installed behind NATs. See Appendix A for more information on how NAT routers work.

There is no default port number used by TSCP. Rather, one is determined each time the Zephyr/IP connects to the ZIP Server. For port forwarding to work, however, the Z/IP ONE's listening port must be static. The ZIP Server setup screen on the Z/IP ONE has a field for setting a static listen port for this purpose.

Media Relay Service

Not all NATs behave the same way. Some NATs are very restrictive, and go to great lengths to prevent data from outside the network from reaching devices on the inside. This is a great security feature for PCs, which typically initiate connections themselves. However, it can create trouble for devices that are listening, waiting for a connection to come in from the outside. The Z/IP ONE, together with the ZIP Server's NAT traversal service can automatically get through most types of NATs.

When both sides are behind very restrictive NATs (especially those referred to as "symmetrical"), it may not always be possible to get through the NAT in a manner that allows the two end devices to communicate directly. However, so long as each Z/IP ONE can communicate with the server, the ZIP Server can exchange the audio data for them.

Direct communication between Zephyr/IPs is always preferred over using the media relay service. We offer the option as a "panic solution," should other methods fail to provide a connection. Units using a direct communication path have a lower end-to-end audio delay, less packet loss, and less jitter between packet arrivals.

If you find yourself behind a very restrictive NAT, but you have control over it (or can ask a network administrator), then it is best to configure port forwarding on the NAT (this is also covered in Appendix A). This will allow your Z/IP ONE to communicate directly with any other Zephyr/IP device without having to rely on the media relay service. Since two Zephyr/IPs can always communicate if even one of them is behind a port forwarding NAT, it is good practice for a Z/IP ONE at a studio or other fixed location to have its ports forwarded.

Direct Connection

Instead of using the ZIP Server, you can make direct TSCP calls as well. To do so, you will dial the IP address and listen port of the remote Zephyr/IP in the standard *address:port* notation. Since this is a serverless connection, you will not have the benefits of the directory server or NAT traversal assistance.

9.2 N/ACIP Session Initiation Protocol

The European Broadcasting Union, recognizing that broadcasters increasingly rely on IP networks to transport audio, defined a standard for connecting between codecs from various manufacturers. This standard is N/ACIP (for “Network / Audio Contribution over IP”). Put simply, N/ACIP defines a connection method, an audio transport method, and a list of codecs that are mandatory, recommended, and optional.

The features of this protocol are:

- ◆ Directory service (optional)
- ◆ Cross-product compatibility
- ◆ Bidirectional audio transfer
- ◆ Agile Connection Technology (on applicable codecs)

Of these things, the part that needs configuration in the Z/IP ONE is the connection method. For this, N/ACIP uses Session Initiation Protocol, or SIP. SIP is a signaling protocol widely used for Voice Over IP (VoIP) applications. Using SIP, the Z/IP ONE is able to accept and make calls to a variety of devices, including some VoIP phones.

SIP can be used in two modes: direct connection, or with a SIP server. Direct mode is what you would expect: one device connects directly to another. A SIP server entry is used when you have established VoIP service, and all VoIP calls are directed by that provider. Another case when a SIP server may be used is when your facility has a VoIP PBX, so the calls may be routed through the PBX. A SIP server acts a bit like the ZIP Server, passing information to its clients so that they may make connections to each other.

SIP server details are entered on the front panel under *Setup->Network->SIP Server*, on the Network web page. If you use a SIP server, enter the hostname or IP address of the SIP server as the “Registrar Hostname,” and then your login details under “Registrar User Name” and “Registrar Password.”

The format of the “registrar user name” is unfortunately dependent on the SIP provider. Your login details will be covered in your SIP server documentation, but there are three common schemes:

- ◆ An extension number. This is common with a PBX, especially those used with VoIP desk phones.
- ◆ A raw user name. This is less likely with a PBX, but it is still possible that a user name is associated with an extension number, and used as the login to the server. In this case, the ‘registrar user name’ field would be something like JohnSmith
- ◆ *username@servername*. This is most common with Internet SIP servers, but it is possible that you could see it in a PBX as well. This format is used when a single SIP server may have multiple identities. It uses the ‘@servername’ portion so that each of its identities can have usernames that would otherwise conflict. You can think of it as the ‘group’ portion of a TSCP identity.

If you have a SIP server defined, all SIP calls will be made using it. The formats to call other users will also be defined by the server. SIP to SIP calls are made like sending an email – *user@server.tld*. However, a PBX may allow you to put in extension numbers, or dial out to the public switched telephone network by entering a phone number in the SIP connection field. Again, consult your SIP server, PBX, or IT department for information on using your SIP server.

9.3 Real-time Transport Protocol

Regardless of whether you use TSCP or SIP to initiate your connection, the audio is sent using the Real-time Transport Protocol (RTP). Rather than using a connection protocol, you may send RTP streams manually.

The features of RTP connections are:

- ◆ Cross-product compatibility
- ◆ Point-to-multipoint operation
- ◆ Unidirectional audio transfer
- ◆ Agile Connection Technology (on applicable codecs)

There are no servers to configure for RTP. To send an RTP stream to another codec, you enter its IP address and port number in the format *ww.xx.yy.zz:port* or, if a hostname is available, *hostname.tld:port*. The remote codec must be listening on that port for a connection, and that port must be open to the public network. On the Z/IP ONE, the RTP listen defaults to UDP port 9150. This can be configured on the second page of the *Setup->Network* menu on the front panel, or on the Network web page.

RTP streams push audio in one direction – from the dialing unit to the dialed unit. Because of this, it can be used in point-to-multipoint operation. To use this function, just issue multiple RTP connections, one after another. The only limit to the number of connections is your outgoing bandwidth. Using the DISC button on the front panel will stop all outgoing RTP streams at once.

Although RTP streams are push-only, you can transfer audio in each direction. To do this, the operator of each codec must send an RTP stream to the other. If this is done, your Z/IP ONE will have all the connection features (including Agile Connection Technology and remote quality information) as if the transfer was started via TSCP or SIP. However, since the call is not handled by a connection manager, each end must still stop its own stream individually.

In some scenarios, this process can be automated. The Z/IP ONE has what we call ‘reciprocal RTP.’ If you send an RTP stream to one of the Z/IP ONE’s reciprocal RTP ports, it will respond to the ‘caller’ with its own stream. This sets up a bidirectional connection, just like using TSCP or SIP, but there is no NAT traversal. The called party must have a port or ports forwarded in order for reciprocal RTP to work.

In addition to the listen-only RTP port, there are three reciprocal RTP ports. These are the next three port numbers above the listen port, and are disabled by default (e.g. if the RTP listen port is 9150, the available reciprocal RTP ports are 9151, 9152, and 9153). Each of these ports has a different behavior, and can be enabled individually if needed:

Port	Default	Effect
Base	9150	Receive Only
Base + 1	9151	Reply with G.722
Base + 2	9152	Reply with same as received codec
Base + 3	9153	Reply with current codec setting

Setting the RTP base port to 0 will disable the RTP receive-only port as well as all reciprocal RTP ports.

10 Making Connections

How you connect to another codec for the first time depends a bit on the type of stream you're using. However, after that first time, most calls can be redialed from the Z/IP ONE's call history, and all types of connections can be added to the Z/IP ONE's phone book.

10.1 Dialing Manually

If you know the details of the connection you want to make, you can simply enter those details and dial.

From the Front Panel

Press the CONN key, next to the dial pad on the far right of the front panel. What information you have to enter depends on the type of call you're making.

- ◆ For a TSCP call assisted by the directory server, enter the device name in the first field and the group in the second.
- ◆ For a direct TSCP connection without the server, enter the IP address and port, and make the group field blank
- ◆ For SIP or RTP calls, put the necessary information all in the first field. For SIP and RTP calls, the group field is ignored.

Next, select the call type from the list in the third field. After the information is entered, pressing the Call button will start the connection.

From the Web Page

All calls are made from the Connect application on the web page. For direct dialing, use the Connect tab. Calling in this way is a little different from using the front panel. Rather than separate fields, all the connection details are entered on the first line. The format is:

protocol:name@address:port

The protocol can be tscp, sip, or rtp. If none is specified, TSCP is assumed. The name@address portion of the line depends on the protocol used. For TSCP, this will be device@group. For N/ACIP SIP, it will be whatever details are needed by your SIP server, or just an IP address for a direct SIP connection. For RTP, this should be just an IP address or hostname. The *port* is optional, only needed if connecting to a nonstandard port. Here are some example addresses:

- ◆ tscp:Testline@public
- ◆ rtp:192.168.3.220:9150
- ◆ sip:95551212
- ◆ sip:jimmy@server.tld

10.2 Using the Phone Book

Dialing manually is fine for a connection that you need to make only once, or only infrequently. For connections that you will use more often, there is an internal phone book that will remember the connection details for you. The phone book can get call information from manual entry, the ZIP Server, or your own call history. Regardless of how the information is filled out, a phone book entry has the following parts:

- ◆ Device name: The name of the device (tscp), or address/hostname (tscp, sip, rtp)
- ◆ Group name: Only used for TSCP
- ◆ Call Type: TSCP, N/ACIP SIP, or RTP
- ◆ Screen name: How this connection appears in your phone book
- ◆ Group password: For TSCP connections, if needed
- ◆ Dial Bit: Up to eight phonebook entries can be assigned to GPIO bits for remote control. See Chapter 12, *Ancillary Data2, Ancillary Data* for more information on using dial bits
- ◆ Redial Mode: If this call is abnormally terminated for whatever reason, from network failures to power loss, it can be redialed automatically. This field chooses how many attempts are made to automatically redial, or if the Z/IP ONE should try to redial forever. It can also be set to use whatever the system default redial setting is, in the *Setup->System* menu.
- ◆ Lastly, you will have the option to *Save*, or *Save with Codec*. Both save the details to your phone book, but the second option takes a snapshot of the current settings in *System->Audio Codec* and saves them with the phone book entry. Every time you call this contact, these codec settings will be used instead of the current global settings. Use this if one of your contacts has different coding requirements.

A phone book entry can be edited at any time after it is saved.

Manual Phone Book Entry

You can enter a phone book item manually in the same manner as you would dial manually. The only differences are the bits of information in the list above that aren't present on the manual connect screen: dial bits and redial mode. From the front panel, choose *Phonebook*, then *Manual add*. From the web page, use the Auto tab of the Autodial application, and click Add. Manually adding an entry via the web page is done the same way as it is on the front panel, rather than via the shorthand notation used on the web page's manual dial screen.

Browsing the ZIP Server

If the contact you are adding is another Zephyr/IP, you can take advantage of the ZIP Server's directory services. This can be used to reduce typing using the front panel keypad, or when you do not know the exact name of the Zephyr/IP you're trying to reach.

From the Front Panel

Select the Phonebook option from the main menu, and then click on *Browse ZIP Server*. This will take you to the group selection screen. Click *Find Groups* to use the ZIP server for a list of groups. You can limit this list by entering text in the *Optional Mask* field. This will cause the server to only return groups that begin with the characters you entered.

After you press *Find Groups*, the group list will be selected and active. Scroll to the group name you want, and press the main control knob to choose it for browsing. If the list is very long, you can press the keypad button that has the first letter of the group name (for example, pressing the 7 key will jump to the first group starting with P).

Choosing a group will take you to another search screen. Here, you will select the device name of the codec in the group that you are trying to reach. Once again, there is an optional mask. In addition, there is an optional group password field – use this to search for Zephyr/IPs that are set to be hidden to non-group members. When you click the *Browse* button, the list will again become selected and active. The shortcut keys to jump to a character in the list work for this list as they did for the group list.

Once you choose a device, the cursor will jump to the *Add...* button. Click this, and you will be taken to the phonebook entry edit screen. This is the same screen used for manual dialing, but with all the device information filled in for the selected unit. You will still have the opportunity to change the redial setting, dial bits, and have the choice of whether to save the current codec settings with this entry.

From the Web Page

The phone book is on the Autodial web page. From its Auto tab, click the Directory button. This will take you to a group search screen, just as the front panel did. Enter in an optional mask, or leave the * to return all groups. Click *OK* to perform the search.

Select the group that you want from the list at the right, and then click *OK* again. This will take you to the device search page. Again, this works like the previous screen, and also as on the front panel: put in an optional search mask, and a group password if required. Press *OK* to search. Then, select a device from the list at the right. Click *Add* to add this device to the phone book, or *Call* to call the device directly. Just as on the front panel, once you select a device to add, you will be taken to the same screen used for adding phone book entries manually. Verify the information and choose any additional phone book entry settings, then click *Save*.

Dialing from the Phone Book

To use the phone book for dialing, press the *Auto* key on the front panel, or use the *Auto* tab of the *Autodial* webpage. The phone book lists its entries by 'screen name' – the user friendly name that you entered when saving the contact to the list. There is a space before each entry for a status icon. A filled circle shows that a Zephyr/IP is currently online. An empty circle means that the directory server knows about the Zephyr/IP in question, but the codec is offline. There is no icon for codecs that are unknown to the server, either because the Zephyr/IP has been offline for more than six months (or renamed), or the entry is not using the directory server (for SIP, RTP, and direct-dialed TSCP entries). On the webpage, this status is shown by highlighting the entry in green, red, or blue, respectively.

You can dial an entry from the front panel by selecting it from the list and then either pressing the main control knob or by pressing the *Auto* key again. From the web page, select the entry from the list on the right hand side of the *Auto* tab's screen, and then click *Call*.

10.3 Call History

In the front panel's History menu, all of your Z/IP ONE's incoming and outgoing calls are kept in a list, arranged by time, with the most recent calls first. Each entry in the list is preceded by an arrow. An arrow to the right (>), pointing to the entry, means the call was from this Z/IP ONE, to the device indicated. An arrow to the left (<), pointing to from the entry, means the call was from the other device, to this Z/IP ONE. A device name prefixed with *sip:* or *rtp:* means that one of those two methods was used to connect. A lack of prefix indicates a TSCP call.

Outgoing calls can always be added to the phone book. Simply select the desired entry from the history list, and then choose *Save Selected*. You will be taken to the now familiar phonebook entry page, as with the previous two methods. You can instead choose to call the selected entry right out of the history list, without adding it to the phone book first.

Incoming calls may also be added to the phonebook from the history list. For best results, the incoming call should be from a Zephyr/IP using its *device@group* name from the ZIP Server's directory service. Incoming calls from SIP and RTP clients can also be added to the phone book, but special care must be taken to verify that the IP and port combination can be used to connect to the codec that called. For these connections, it is worthwhile to attempt a call before saving to the phone book.

11 Mobile Network Devices

The Z/IP ONE supports a variety of mobile network devices via the USB port on the back of the unit. To use one:

1. Boot the Z/IP ONE without the USB device plugged in
2. Once the unit has completed the boot process and is showing the main menu screen, plug one of the approved mobile devices into either of the USB ports on the back of the Z/IP ONE
3. Navigate to the *Setup->Network* menu and continue as follows for the type of network to be used

11.1 WiFi/WLAN Networks

1. Press the ESC key to access the main menu. Using the control knob, navigate to *Setup>Network>WiFi/WLAN*. Press the control knob to select
2. Rotate the control knob to highlight the relevant fields and press to select them. Use the keypad to enter necessary information for the encryption method, the ESSID network name, and the password string. As an alternative to typing the ESSID, you may use the *Browse SSIDs...* button and select your wireless network from the list. Your WiFi access point must be configured to broadcast SSIDs in order to use this option. Enter the ESSID and password exactly as they are set up on the router, as these names are typically case sensitive. Once entered, scroll down and click on *Activate Settings*
3. Press the ESC key to return to the Setup menu. Turn the control knob to highlight *Streaming Interface* and press the control knob. Change the option to WiFi/WLAN, and then press the control knob again to accept the change
4. Press the ESC key twice to return to the status screen. Once the WiFi interface is configured and can be used to access the network, the ZIP indicator will fill in. This indicates that your Z/IP ONE is connected to the Internet and is ready to use

11.2 UMTS/EVDO Wireless Networks

1. From the *Setup->Network* menu choose the *UMTS/EVDO* option
2. Set the country, protocol, dial number, PIN, account name, account password, and provider URL. All of this information is supplied by your wireless service provider
3. Select *Activate Settings* to commit your settings to memory and begin using them
4. Press the ESC key to return to the Setup menu. Turn the control knob to highlight the *Streaming Interface* option, and press the knob to edit it. Choose *UMTS/EVDO* from the list, and press the control knob again to set that value
5. Press the ESC key twice to return to the status menu. When the UMTS/EVDO device is configured correctly and has access to the wireless data network, the ZIP status indicator will fill. This shows that the Z/IP ONE has access to the Internet and is ready to use

Also, note that your EVDO device must be activated, using a computer, with the software that comes with it. Please follow any directions that came with the device and contact your service provider for assistance if necessary. Once you have verified it is operating as intended, follow the steps above.

EVDO Devices Supported

Originally, the Z/IP ONE supported the following EVDO devices:

1. Sierra Wireless USB device AC595U for either Sprint or Verizon
2. Novatel Ovation U727
3. Novatel Ovation U720

Since then, USB EVDO devices and carriers have changed too rapidly for us to be able to maintain a compatibility list that is of any use. Some devices on some carriers may still work – it is worth trying. However, for the best chance of compatibility, we now recommend the use of Cradlepoint™ wireless data to Ethernet bridges. Cradlepoint specializes in wireless accessory compatibility, and works seamlessly with a Z/IP ONE. Choose a model that converts wireless data to wired Ethernet, and you can set your Z/IP ONE to stream via the WAN or LAN port, just as though it was connected to a wired Ethernet router.

12 Ancillary Data

Along with the coded audio, the Z/IP ONE is able to send associated data. One example of how this is used is for sending connection quality statistics to the remote Z/IP ONE. This data channel is also available to send user data to the remote codec.

12.1 GPIO

The first use of the ancillary data channel is for sending General Purpose Input/Output (GPIO) signals. These are individual signals, or bits, that can be used to control or read status from a local Z/IP ONE or send information to a remote Zephyr/IP.

The Z/IP ONE has a DB25 connector on the back panel that provides contact closures (close-to-ground) inputs and outputs. In addition, the Z/IP ONE supports Livewire GPIO. While only one of these may be used for inputs at any given time, the outputs are always available on both interfaces.

PARALLEL PORT PIN	LIVE WIRE PORT	LIVEWIRE BIT	FUNCTION
1			+5 Volts DC, 400mA maximum
2	GPI 1	1	Output 1
3	GPI 1	2	Output 2
4	GPI 1	3	Output 3
5	GPI 1	4	Output 4
6	GPI 2	1	Output 5
7	GPI 2	2	Output 6
8	GPI 2	3	Output 7
9	GPI 2	4	Output 8
10			No Connection
11			No Connection
12			No Connection
13			No Connection
14	GPO 1	1	Input 1
15	GPO 1	2	Input 2
16	GPO 1	3	Input 3
17	GPO 1	4	Input 4
18	GPO 2	1	Input 5
19	GPO 2	2	Input 6
20	GPO 2	3	Input 7
21	GPO 2	4	Input 8
22			No Connection
23			No Connection
24			No Connection
25			Ground

Status Outputs

The eight general purpose outputs can each be set to one of nine operating modes:

1. *Off* – the output signal is never asserted
2. *On* – the output signal is always asserted (you can use this to verify that the Z/IP ONE is powered on and working)
3. *End-to-end* – for calls made using codecs that support end-to-end contact closures, the output signal will reflect the state of the corresponding input signal at the far end of the call
4. *Connected* – the contact closure will remain off until a call is connected, at which time it will assert. This function effectively mimics the connect light on the first status page of the front panel interface
5. *Receive Locked* – the contact closure will remain off until a call is connected, and the correct codec type has been determined, and it has detected valid data. This output is an indication that audio should be present, and if it is not, that silence is being transmitted from the far end
6. *Follow Input* – This is a diagnostic mode for locally testing the connections to the inputs and outputs. When this mode is used, the output asserts whenever the corresponding input has been triggered, and will remain so until the input is no longer asserted
7. *Disrupted Call* – if a call drops unexpectedly, this output is asserted. The output will remain on until a call is reestablished, or the operator manually cancels a redial attempt
8. *Lost Packet* – this output will assert briefly each time the decoder records a packet loss
9. *Bad Quality* – This output asserts any time the number of unusable packets crosses a certain threshold. This includes both lost packets and packets that arrive with errors, rendering them unusable. The threshold is user-definable, the setting for which can be found on the same front panel and web pages as the status bit assignments. This output is updated once every three seconds

Status Inputs

The eight general purpose inputs can each be set to one of six operating modes:

1. *No function* – the input is not used, and any activity on the pin is ignored
2. *End-to-end* – for calls made using codecs that support end-to-end contact closures, this input signal will be reflected by the corresponding output signal at the far end of the call. The far end status output will only trigger if it is also set to end-to-end
3. *Disconnect* – if this input is asserted, the Z/IP ONE will immediately disconnect any connected calls
4. *Panic Dial* – if this pin is asserted, the Z/IP ONE will immediately dial the phone book entry that has been configured for this pin. See Chapter 10 for more information on the phone book, and how to configure contacts for use with panic dial inputs
5. *Transmit 0* – this will send data to the corresponding bit of the far end codec indicating that the given input bit is unasserted. This can be used for troubleshooting, or as a simple identifier to distinguish different codecs at the far end. The far end's status output will only reflect this change if the corresponding output bit is set to end-to-end
6. *Transmit 1* – this will send data to the corresponding bit of the far end codec indicating that the given input bit is asserted. This can be used for troubleshooting, or as a simple identifier to distinguish different codecs at the far end. The far end's status output will only reflect this change if the corresponding bit is set to end-to-end

Parallel Port

There are 8 open-collector outputs, and 8 open-collector inputs, each configurable from the Settings menu in the user interface. The DB25 connector is pinned out as follows:

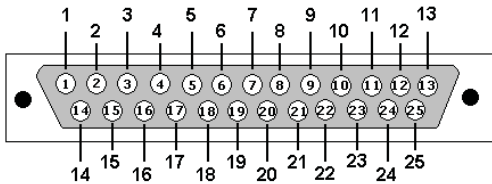

DB25 Male Connector

Parallel Outputs 1-8

Outputs are open collector to ground, and can sink up to 125mA of current each (actually, any output can sink up to 400mA, however the maximum combined current should be kept below 1000mA). When an output signal is active (i.e. “asserted”), the output pin will connect to ground. An equivalent schematic for the outputs is shown below.

If you wish to interface directly to 5 volt logic inputs, the outputs include a pull up resistor to 5 volts. If you need a logic high greater than 5 volts, you may supply an external pull up resistor (2.2kΩ to 10kΩ is appropriate) to the voltage level required by your external logic inputs. You cannot use a voltage level less than 5V, however you may use up to 50V.

If used with a relay or LED, then tie your external power source ground to pin 25 (or use the 5VDC power supplied on pin 1), and run this power source through your device, with a resistor in series to limit maximum current to less than 125mA.

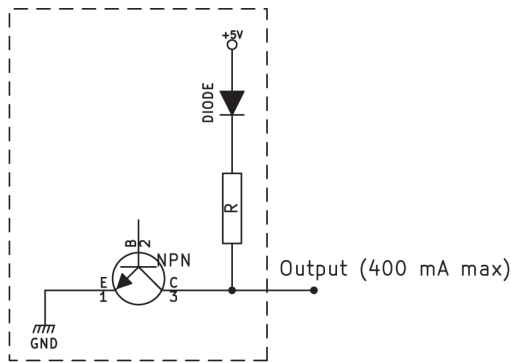

Equivalent circuit for the parallel outputs

Parallel Inputs 1-8

All inputs are specially treated to accept either a voltage (up to 24 VDC), or a closure to ground, which may be provided by switches, relays, or logic outputs. The inputs are active low. In other words, shorting the input to ground causes it to become true (i.e. “asserted”).

An internal pull-up resistor is used to provide a TTL logic “high” (e.g. 2.2k Ω to 5V).

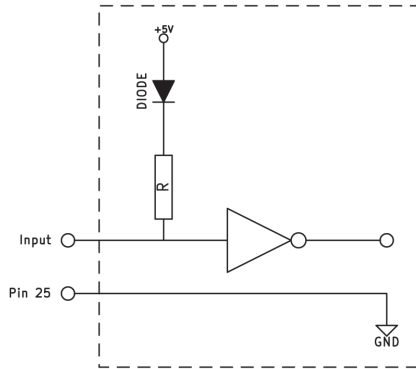

Equivalent circuit for the parallel inputs

Livewire GPIO

In addition to the physical GPIO, the Z/IP ONE has a virtual, network-enabled GPIO that uses the Livewire protocol. You may take advantage of networked GPIO even if you don't use Livewire for audio delivery.

Livewire GPIO “channels” have five input signals and five output signals apiece, each equivalent to a pin on the parallel port. The Z/IP ONE has eight parallel input signals, an eight parallel output signals. To access them all, there are two Livewire GPIO channels, and the first four bits of each are used (the fifth is ignored both for inputs and outputs).

Output signaling is always available. To configure an Axia device to follow the Z/IP ONE's status output bits, configure it to follow the GPIO using the following syntax (sometimes referred to as “GPIO snake”):

```
ww.xx.yy.zz/#
```

Where *ww.xx.yy.zz* is the IP address of the Z/IP ONE's LAN port, and *#* is the number of its GPIO (e.g. 172.16.1.140/1). Use a port of 1 for status bits 1-4 and port 2 for bits 5-8.

To use Livewire for input signaling, configure a source to follow on either the *Setup->Parallel Port Configuration* menu on the front panel, or the *General Settings* webpage. In either location, use the same IP/Port syntax. If a network GPIO address is entered in these fields, the Z/IP ONE will use Livewire as the inputs to those bits. If the field is empty, it will use the back panel GPIO for inputs.

In some cases, you may want to use Livewire GPIO signaling for the Z/IP's input signals, but not follow any other device. An example of this would be using the *Pathfinder* network management software to define events that trigger the Z/IP ONE's GPIO input signals. To do this, configure the Z/IP ONE to listen to a GPIO signal that does not exist. An easy way to guarantee this is to use the Z/IP ONE's own IP address with port numbers of 3 and 4. This tells the Z/IP ONE not to use the parallel port for signal inputs, but it gives it a Livewire GPIO signal that will never change on its own.

GPI versus GPO

In the above introduction, you may have noticed that we referred to Livewire GPIO input signals and output signals. However, in the Livewire world, these are referred to as GPIs and GPOs, individually. Why the difference? This is a technical distinction that will not be important for most users, but if you are curious as to the answer, read on.

In the Livewire world, GPI (general purpose input) and GPO (general purpose output) are always relative to the ports of the dedicated Livewire GPIO node. This is a device that has many banks of parallel ports, and converts physical inputs and outputs to Livewire GPIO signals. Consider a device that has no Ethernet port. To use Livewire GPIO with it, you would use a GPIO node, and connect the two device's parallel port pins together, like this:

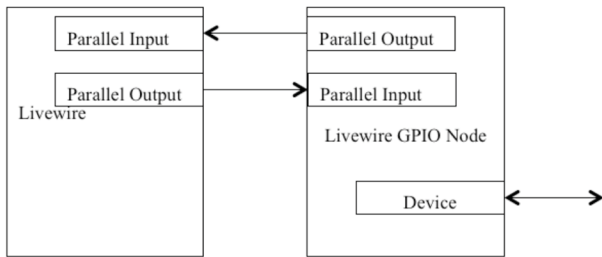

When the device triggers a status output on its parallel port, it is sent to the Livewire GPIO node's input, and is presented to the Livewire network as a Livewire GPI signal.

Other Livewire products that are interested in a device's status OUTPUT changes listen to the GPIO node's INPUT changes. The reverse direction works in a similar manner. The GPIO node subscribes to another node's GPI. In response, it triggers its parallel port output, and generates a Livewire GPO message to reflect that its output changed. The device's INPUT change is accompanied by a Livewire GPO message.

Now, consider the Z/IP ONE: Although it has Livewire natively, it must present its input and output signals to the network in the same manner. You can think of it as having a tiny GPIO node stuffed in the same box – a status OUTPUT generates a Livewire GPI message:

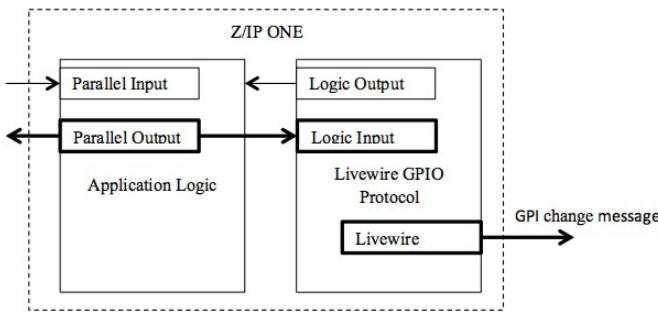

In this manner Livewire GPIO is analogous to Livewire Audio. The audio that goes out the XLR outputs is what shows up on the Livewire network as a Source. The logic signal that goes out the parallel port output is what shows up on the Livewire network as a GPI.

12.2 Serial Data

In addition to GPIO data, the Z/IP ONE can send low-bitrate serial data. Where GPIO is a series of discrete signals, serial data is sent as a constant stream. The Z/IP ONE can transfer serial data at a sustained rate of 9600 bits per second, and can send binary data as well as text.

To send serial data, the Z/IP ONE needs a USB-to-RS-232 adapter. This is available from Telos as an accessory, part number 2091-00140. As of this writing, we specify a Syba SY-ADA15006. You may try any adapter that uses the PL-2303 chipset, common among USB-to-serial adapters.

Since the Z/IP ONE is a USB host device, it acts as Data Terminal Equipment (DTE). Serial devices which communicate as Data Circuit-terminating Equipment (DCE) may connect to the 9-pin connector directly. To use the Z/IP ONE with another DTE device (such as a computer or laptop), a null modem will be required. The serial port on the communicating device should be set to 9600 bits per second, 8 data bits, no parity, and one stop bit (9600 8N1).

Plug the USB-to-serial adapter into either of the Z/IP ONE's USB ports. In a moment, a message will appear on the display informing you that the adapter is ready to use. When the adapters are installed in both Z/IP ONEs, make a bidirectional connection between them. When the decoders lock, any serial data entered into one device will be sent to the other, and out its serial port.

The serial data is correlated to the audio, with a small offset in time. Bidirectional communication is possible, but any equipment using this for unattended communication must be able to tolerate the end-to-end delay in communications. Also, just as audio data may be lost in transit, so may serial data. We compensate for this in the audio codecs by using error concealment to hide the loss. Any serial communications equipment must likewise be able to compensate for lost data.

Appendix A - When an IT Department Is Not Available

There are times when an IT department is not on hand to guide you through some of the ins and outs of networking. This appendix covers some of the basics to get you started.

IP Addresses, Subnet Masks, and Gateways

This section describes the terms used in IT environments. You probably already know these terms, but we included them here for completeness. The terms covered are IP addresses, subnet masks, gateways, DNS, and DHCP. Network Address Translation (NAT) is covered in its own section, below.

IP Addresses

Internet Protocol (IP) addresses identify electronic devices that are part of an IP network. The protocol uses these addresses to properly route the data to the destination. Without Network Address Translation (see below), every device connected to a common network would require a unique address.

There are two versions of IP. The current version is called IPv4, and that is what we refer to in this manual. IPv6 is a newer standard that is not yet widely deployed.

IPv4 addresses consist of a 32-bit number. To make it easier for humans to describe, IP addresses are written in a form called dotted decimal notation. To come up with a dotted decimal representation, the 32-bit number is broken down into four parts, each 8 bits long. Each part is converted to a decimal number and written out with a dot in between.

For example, a device that has a 32-bit IP address of 3,232,235,841 is commonly written out as 192.168.1.65. The figure below shows how this conversion takes place.

IP number	3, 232, 235, 841			
	↓			
Binary	11000000	10101000	00000001	01000001
	↓	↓	↓	↓
Decimal	192	. 168	. 1	. 65

I hope you agree that 192.168.1.65 is easier to remember and talk about than 3,232,235,841.

Subnet Masks

Larger networks are often broken down into subnets. Subnets make the network easier to manage. Subnets are connected to each other by routers: devices that route the packets between networks. The Internet Protocol differentiates between local addresses (addresses on the same subnet) and remote addresses (on different subnets). It uses the subnet mask to accomplish this task. Subnet masks might also be called netmasks or IP masks.

Before we get too deep into binary numbers, host and network address parts, you should be aware that you can safely treat the subnet mask as just another parameter to set when you configure an IP address. No deep understanding is required to find out what the local subnet mask is and to configure it for your IP device.

We should also mention that one of the most commonly used subnet masks is 255.255.255.0. Read on to find out why.

Network and Host IDs

To deal with subnets, IP treats the IP address as consisting of two separate IDs: A network ID and a host ID. The network ID identifies the subnet while the host ID identifies the actual device on the subnet. If two devices have addresses with the same network IDs, then they are on the same subnet and are able to exchange data directly. If not, then they are on different subnets. Any data exchange between them would have to go through a router.

The protocol needs to split the IP address into the network and host parts so that it knows where to send the data packets. It accomplishes this splitting by using the subnet mask.

A subnet mask is a 32-bit number and is commonly written out in dotted decimal notation, just like an IP address. If you write it out as a binary number, you will notice that it consists of a string of ones followed by a string of zeroes. The ones indicate (they “mask”) the network portion of the IP address while the zeroes indicate the host portion.

An example might explain this better. Using the same IP address as above, 192.168.1.65 with a subnet mask of 255.255.255.0 we found out that the network ID is 192.168.1.0, while the host ID is 65. Here is how we did it:

Step 1: Convert the mask to binary and we get 11111111 11111111 11111111 00000000

Step 2: Convert the IP address to binary as well:

Decimal	192	. 168	. 1	. 65
	↓	↓	↓	↓
IP Address	11000000	10101000	00000001	01000001
Mask	11111111	11111111	11111111	00000000
	⏟			⏟
	Network			Host

Step 3: For each 1 in the subnet mask, keep the corresponding IP address bit as is, and for each 0, convert the corresponding bit to 0. We end up with:

11000000 10101000 00000001 00000000 (or 192.168.1.0)

This is the network ID part of the IP address.

Step 4: Now, we invert the mask. For each 0 in the subnet mask, keep the corresponding IP address bit as is, and for each 1, set the corresponding bit to zero. We get:

00000000 00000000 00000000 01000001 (or 65)

As you might know, computers love ones and zeroes and built-in binary operations make it a breeze to perform the network/host splitting. In a language like C or C++, the splitting would look like this:

```
Network id = ip_address & mask;
host_id = ip_address & (~mask);
```

IP Address Classes

Find, you say. That was mildly entertaining. But why muck about with subnet masks and binary operations? Why can't they just always use the first three bytes for the network ID and the last byte for the host ID?

That is a fair question. The answer is that not every subnet is the same. Some corporate subnets are very large and have lots of hosts, while some small subnets may have only a handful. The number of bits allocated to the host ID determines the maximum number of IP address you can have on the subnet. An 8-bit host ID would allow for a subnet with a maximum of 255 hosts. That would not be enough in some cases.

The subnet mask solves this problem (although perhaps in an awkward way). On subnets with lots of hosts, you can use fewer bits for the network ID and more bits for the host ID. On subnets with fewer hosts, you can use more bits for the network ID and fewer bits for the host ID.

If you're managing a private network, you're free to select your subnet mask as you like. But on the internet, subnet masks are assigned by IP address class.

There are three common IP address classes: A, B, and C. There is also a class D used for multicast classes, and a class E reserved for future use, but here we'll only look at the first three:

Class	IP Address Range	Subnet Mask
A	0.0.0.0 to 127.255.255.255	255.0.0.0
B	128.0.0.0 to 191.255.255.255	255.255.0.0
C	192.0.0.0 to 223.255.255.255	255.255.255.0

Class C is the most common IP address class, so most of the subnet masks you see will likely be 255.255.255.0.

It is possible to have different subnet masks in addition to the ones above. The one thing to remember is that when converted to a binary number, subnet masks are always a continuous string of 1s followed by a string of 0s.

Windows Calculator can perform decimal, binary, hex, and octal number conversions as well as some binary operations, but by default these capabilities are hidden. To reveal these function select 'Programmer' mode from the View menu.

Most of the time you will not have to give subnet masks much thought. But there may be times when you are given an invalid subnet mask, and this information may help you to detect it, saving you some aggravation.

Gateways

We talked about networks having multiple subnets. Hosts on a subnet are able to communicate directly with each other, but what happens when a host needs to communicate to another that is on a different subnet? Simple: It uses the subnet mask to compare the network part of its address versus the network part of the other device's address. If they are different, it sends the packet to the gateway address instead.

The gateway is the router device that will take care of sending the packet on its way to the destination when the packet cannot be delivered on the local subnet. In a way, it is similar to dropping off a piece of mail at the local post office. They will take care of getting it to the destination for you.

Gateway addresses often end with .1 or .254. This is not a requirement; they could end with any number between 1 and 254. It is only a convenience because it leaves a continuous range of numbers that can be used by local hosts.

What about ending with .255 you ask? It is true that the largest possible value is 255 (or 11111111 in binary). But addresses that end in all ones have a special meaning in the Internet Protocol. They are local broadcast addresses. A packet sent to such a broadcast address (.255 on a class C network, .255.255 on a class B network, etc.) will be sent to all hosts on the local subnet.

DNS

DNS stands for Domain Name System, and in some ways it is similar to how the telephone book works: if you know the name, you can look up the corresponding phone number to dial. DNS servers allow IP devices to find the IP address that corresponds to a given name (like telos-systems.com). The device can then use the IP address to talk to the host that has the name. Without a DNS server you would not be able to use address names, only raw numbers.

DHCP

The Dynamic Host Configuration Protocol (DHCP) is a method of handing out IP address to IP devices on a network in a dynamic fashion. When an IP device that is configured to use DHCP is powered up (or connected to the network), it broadcasts a request for IP configuration information on the subnet. If a DHCP server is available, it will allocate an unused IP address from a user specified range and respond back to the device. The device can then configure itself with this IP address.

Using DHCP is a convenient method to configure an IP device, but it is not always the best course of action. When you use DHCP you don't know the assigned IP address of the device, plus this address may change from time to time. This is usually not a problem, but in some cases it can be. If you need to configure the Z/IP ONE via a web interface, you will have to check the currently assigned IP address on the device via the front panel. Another situation where you do not want to use DHCP is if you wish to configure port forwarding on your NAT (see below), since you must forward each desired port to specific internal IP address.

Discover the Local Network Settings

You need to plug your Z/IP ONE into a network, but you don't know the network settings. If there is no one to ask, what can you do?

Well, if there is a PC already plugged into the same network, then you can check the network configuration on the PC to determine the available network settings. The directions here are for a Windows PC.

1. Press and hold the windows key, then press R to bring up the windows Run dialog box. Type "cmd" (without quotes) in the dialog, and press enter.

You can also launch cmd from the start menu, but the steps to do this vary between versions of Windows.

- In the command prompt window that appears, type “ipconfig /all” (again, without the quotes) and press Enter. You should see some entries similar to the ones shown below:

```

C:\WINDOWS\system32\cmd.exe
Ethernet adapter Wireless Network Connection:

    Media State . . . . . : Media disconnected
    Description . . . . . : Intel(R) PRO/Wireless 2915ABG Network
    Connection
    Physical Address. . . . . : 00-16-6F-3B-D9-E3

Ethernet adapter Local Area Connection:

    Connection-specific DNS Suffix . . . . . :
    Description . . . . . : Marvell Yukon 88E8053 PCI-E Gigabit
    Ethernet
    Controller
    Physical Address. . . . . : 00-0E-7B-68-27-6A
    Dhcp Enabled. . . . . : Yes
    Autoconfiguration Enabled . . . . . : Yes
    IP Address. . . . . : 192.168.123.101
    Subnet Mask . . . . . : 255.255.255.0
    Default Gateway . . . . . : 192.168.123.254
    DHCP Server . . . . . : 192.168.123.254
    DNS Servers . . . . . : 69.75.169.15
    . . . . . : 69.75.169.16
    Lease Obtained. . . . . : Sunday, November 04, 2007 9:51:18 AM
    Lease Expires . . . . . : Monday, November 05, 2007 9:51:18 AM

C:\>

```

If the PC has multiple network adapters, you will see multiple entries displayed. In the example above, the PC has a wireless adapter and the Media State for it is shown as disconnected, which indicates that the wireless is currently disabled.

Following this is an entry for the “Local Area Connection” Ethernet adapter. In our case, this is the entry of interest, because it is plugged into the same Ethernet network that we want to learn more about. The section of interest is under the heading “Ethernet Controller” and contains the following interesting entries:

- ◆ DHCP Enabled: Yes – This indicates that this PC was configured for DHCP, so there must be a DHCP server available.
- ◆ IP Address: 192.168.123.101 – IP address assigned by the DHCP server
- ◆ Subnet mask: 255.255.255.0 – This is the network mask for this subnet. We can use the same network mask for the Z/IP ONE.
- ◆ Default Gateway: 192.168.123.254 – Another important entry, we can use the same gateway address on the Z/IP ONE
- ◆ DNS Servers: 69.75.169.15 and .16 – DNS server addresses. Use the first one on the Z/IP ONE as well.
NOTE: The values in this example are not valid. Do not use these values on your Z/IP ONE!

The ipconfig command will give you the subnet mask, gateway, and DNS server addresses. It does not directly give you the IP address you should use on the Z/IP ONE. If DHCP is available, as it is in this example, you can just configure the Z/IP ONE to use DHCP. It will obtain an IP address, network mask, gateway, and DNS server settings automatically. If DHCP is not available, then read on. The next section will describe this case.

Find an Available IP Address without a DHCP Server

What can you do if a DHCP server is not available on your network? In this case, we'll search for an IP address by pulling one out of a hat, then testing to see if it is already in use.

In the example above, the PC's address was 192.168.123.101, and the subnet mask was 255.255.255.0. This means that the last eight bits indicate the host portion of the address. On this network, valid IP addresses would run from 192.168.123.1 to 192.168.123.254. Right away, we'll avoid .1 and .254 because they are often assigned to the gateway. That leaves numbers from 2 to 253, still a pretty big range. So just choose a number: I prefer to start with the lower numbers for no particular reason. For this example, I chose 10, so my first IP address to test will be 192.168.123.10.

1. Press and hold the windows key, then press R to bring up the windows Run dialog box. Type "cmd" (without quotes) in the dialog, and press enter.
You can also launch cmd from the start menu, but the steps to do this vary between versions of Windows.
2. In the command prompt, type "ping" followed by the trial IP address you selected (I'll use 192.168.123.10 here), then press enter.

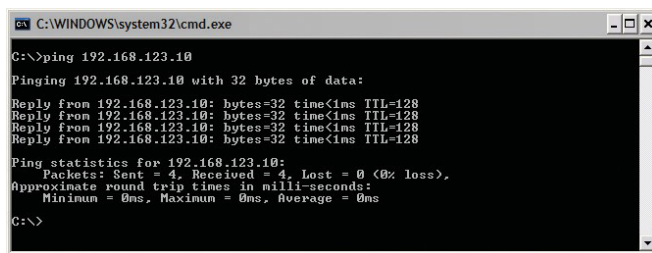

```
C:\WINDOWS\system32\cmd.exe
C:\>ping 192.168.123.10
Pinging 192.168.123.10 with 32 bytes of data:
Reply from 192.168.123.10: bytes=32 time<1ms TTL=128
Reply from 192.168.123.10: bytes=32 time<1ms TTL=128
Reply from 192.168.123.10: bytes=32 time<1ms TTL=128
Reply from 192.168.123.10: bytes=32 time<1ms TTL=128
Ping statistics for 192.168.123.10:
    Packets: Sent = 4, Received = 4, Lost = 0 (0% loss),
    Approximate round trip times in milli-seconds:
        Minimum = 0ms, Maximum = 0ms, Average = 0ms
C:\>
```

3. We got a reply to our "ping." That means that the IP address I selected is in use by another device, so we can't use it. Let's try another. I will choose .15 this time:

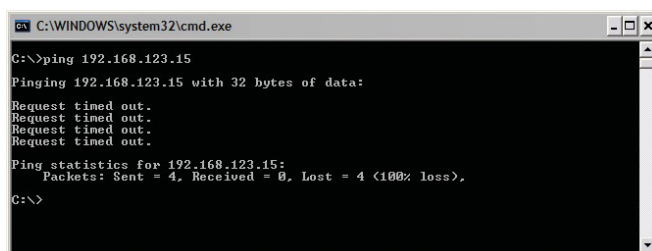

```
C:\WINDOWS\system32\cmd.exe
C:\>ping 192.168.123.15
Pinging 192.168.123.15 with 32 bytes of data:
Request timed out.
Request timed out.
Request timed out.
Request timed out.
Ping statistics for 192.168.123.15:
    Packets: Sent = 4, Received = 0, Lost = 4 (100% loss),
C:\>
```

4. Much better. The time out messages indicate that no device responded at this address. This is a pretty good indication that we can use this address. But let's double check to be sure. There are some IP devices that may be configured not to reply to pings.

- At the command prompt, type “arp -a”. Make sure you do this right after the unsuccessful ping command. This command displays the physical addresses associated with IP addresses that have been recently used.

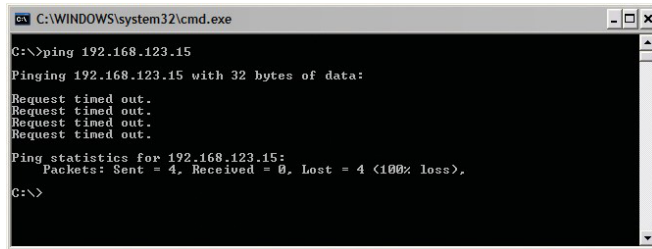

```

C:\WINDOWS\system32\cmd.exe
C:\>ping 192.168.123.15
Pinging 192.168.123.15 with 32 bytes of data:
Request timed out.
Request timed out.
Request timed out.
Request timed out.
Ping statistics for 192.168.123.15:
    Packets: Sent = 4, Received = 0, Lost = 4 (100% loss),
C:\>

```

- The table shows one entry for the 192.168.123.10 address which we discovered in step 2, above. It does not show an entry for 192.168.123.15, which indicates that no device answered this address. If there had been an IP device that does not answer pings, we still would expect to see its address in the arp table.

With this last test complete, we can be pretty confident that at this time, the 192.168.123.15 address is available. There is no guarantee that this address will remain valid forever. There may be a PC that uses this address that just wasn't turned on at the moment. So keep an eye out for signs of duplicate IP addresses on the network. And notify your IT department (or whoever is responsible for assigning IP addresses within the organization) ASAP that you are using this address. Read the following section for the gory details.

Duplicate IP Addresses

Duplicate IP addresses can be difficult to diagnose. Some PCs may give you a warning at boot up that the currently configured IP address is in use. But other times, duplicate IP addresses are only discovered when an IP device behaves strangely. For example, you know you assigned a particular IP address to your Z/IP ONE, but now you cannot open the web configuration page at that address. Or perhaps, sometimes it works, but other times, it does not.

The method to diagnose a duplicate IP address conflicting with your Z/IP ONE is to learn the hardware address (also call the physical or MAC address) of your Z/IP ONE, and to use the “arp -a” command from a PC to watch the hardware address associated with your Z/IP ONE's IP address. Your Z/IP ONE's hardware address is available on the interface status page for each available streaming interface.

If you ever find a different hardware address associated with your Z/IP ONE's IP address, it is time to call your IT department. Or, if an IT department is not available (since you're reading this section anyway), just assign a different IP address to your Z/IP ONE.

Network Address Translation

What is it?

Network Address Translation (NAT) is a technique that allows multiple IP devices on a private network to share a single public IP address. A NAT device has two network ports, one for the “private side” (the LAN) and one for the “public side” (the Internet). As the name suggests, the NAT router translates the internal IP addresses to the public IP address.

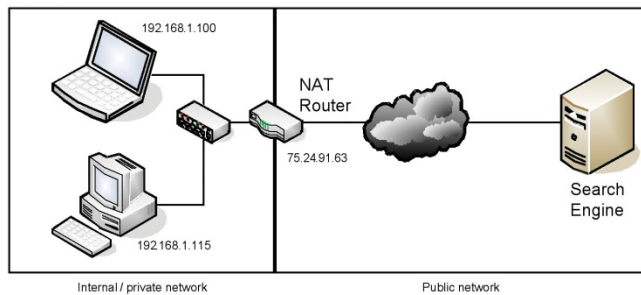

In the example drawing above, the laptop sends a request to a search engine. The packet is labeled with the IP address of the laptop, 192.168.1.100. The NAT router intercepts the packet and changes the packet to replace the laptop’s IP address with the public IP address assigned to the router (in this example, 75.24.91.63), then sends the packet to the destination. The server responds to the IP address embedded in the packet, so the packet is sent back to the NAT router. The NAT remembers that the initial request came from the laptop, so the packet is sent to it. As far as the laptop is concerned, it does not know, nor does it care, that there is a NAT device in between.

Are all NAT devices the same?

Not all NAT devices are the same, as there is no defined standard on how a NAT should behave. Each vendor implements the NAT functions in a proprietary manner. You may hear NATs described as full cone, restricted cone, port restricted cone, or symmetric. Not everyone agrees on the exact definition of these terms. A Wikipedia article (http://en.wikipedia.org/wiki/Network_address_translation) does a good job attempting to describe them. Perhaps counter intuitively, symmetric NATs are among the most restrictive.

How do NAT devices affect communication devices?

NAT has some benefits and drawbacks. It is a lower cost solution compared to obtaining multiple public addresses, and it adds to security by hiding the internal structure of the network, and by allowing only pre-specified direct contact via port forwarding (see below). However, internal devices are no longer reachable from the outside because the NAT does not know which internal device the packet is destined for.

To get around this drawback, NATs have configuration capabilities which allow the user to forward specific ports to a given internal device, or to add a single device DMZ (De-Militarized Zone) where the device is now visible to the public.

How does the ZIP Server help?

Making NAT configuration changes can be cumbersome. The Z/IP ONE uses the ZIP Server to detect if it is installed behind a NAT, and then determine the type of NAT as well. It is then able to accept calls from the outside without requiring you to make special configuration changes to your NAT. In addition to NAT traversal assistance, the ZIP Server also allows you to see the status of your “contact” devices, to get a directory listing of available devices, or to dial another device by name.

How do I use port forwarding with the Z/IP ONE?

A common technique to help devices behind NATs communicate is to use port forwarding. When you use port forwarding, you tell the NAT that any time it receives data at a particular port number, it should forward that data packet to a specific internal device.

The Z/IP ONE is able to communicate through most types of NATs without requiring any special configuration of the NAT. But some NATs are much more restrictive than others. Establishing a connection becomes even more difficult when both ends are behind very restrictive NATs. Port forwarding can help in these cases. If at least one of the sides uses port forwarding, then a direct connection can be established much faster.

You can use port forwarding with the Z/IP ONE in two steps:

1. On your Z/IP ONE, in the *Setup->ZIP Server* configuration page, enter a value for the listen port. The default value is zero, which tells the Z/IP ONE to select a port on its own. You can choose any value from 1024 to 65,535, but please make a note of it. Also make a note of the IP address you assigned to the Z/IP ONE (this is one of those cases when you should not use DHCP)
2. On your NAT's configuration page, specify the port that you selected in step 1 above should be forwarded to the Z/IP ONE's IP address.

If you have more than one Z/IP ONE behind a NAT, and you use port forwarding, you need to make sure that each Z/IP ONE uses a different port. Some NATs may get very confused otherwise

Appendix B - Audio Coding Reference

History

Audio takes up a lot of data. Just a regular phone call uses 64,000 bits per second.

Without data reduction, CD-quality audio – 16 bits at 44.1 kHz sample rate – requires a transmission capability of about 706 thousand bits per second (kbps) for each audio channel. But the wires originally used for remote broadcasting on the public switched telephone system were designed for voice-grade communications: 8 bits at 8kHz sample rate, or 64 thousand bits per second (kbps) per channel. That's 11% of what we needed.

Curiosity Note!

You can arrive at these same numbers with nothing more complicated than grade-school math. Just multiply the sample rate by the sample depth: 44,100 samples per second * 16 bits per sample = 705,600 bits per second for CD-quality mono audio. Multiply by 2 for stereo.

You can reduce the data requirements by lowering the quality somewhat. 13 bits would yield a respectable 78 dB dynamic range, certainly adequate for casual home listening. And a 32 kHz sample rate, with careful equipment design, will give you flat response to 15 kHz, the practical limit for analog FM broadcasting in North America. Unfortunately, that still left us with telephone data channels about 93% too small to do the job. Besides, 13 bits is an awkward bit depth (resolution) for computers to deal with, and the audio it produces wasn't clean enough to survive transmitter processors.

Curiosity Note!

Bit depth and sample rate translate easily into audio specifications. Digital audio must have a sample rate of at least twice the desired bandwidth, so 15 kHz audio requires (after a safety margin) 32 kHz sampling. Each bit of sample depth represents slightly more than 6dB of dynamic range.

The first practical coding methods used a principle called ADPCM: Adaptive Delta Pulse Code Modulation. This took advantage of the fact that it takes fewer bits to code the difference, or delta, between successive audio samples compared to using the individual values. Further efficiency was gained by adaptively varying the difference comparator according to the nature of the program material. G.722 and aptX are examples of ADPCM schemes. They achieve around a factor of 4:1 reduction in bitrate.

G.722 achieves additional efficiency by allocating its bits to match the patterns in the human voice, and it's considered adequate for news and talk programming over ISDN. But, for high-fidelity transmission, algorithms with more power are required. These are based on psychoacoustics, where the coding process is adapted to the way we hear sounds. There are several algorithms available, with varying complexity and performance levels.

Some years ago, the standards group ISO/IEC established the IOS/MPEG (Moving Pictures Expert Group) to develop a universal standard for encoding moving pictures and sound for digital storage and transmission media. The standard was finalized in November 1992 with three related algorithms, called Layers, defined to take advantage of psychoacoustic effects when coding audio. Layer 1 and 2 were intended for compression factors of about 4:1 and 6 or 8:1, respectively. These algorithms became popular in satellite and hard-disk systems. Layer 3 achieved compression of up to 12.5:1 – 8% of the original size – which made it ideal for ISDN.

Basic Principles of Perceptual Coding

With perceptual coding, only information that can be perceived by the human auditory system is retained.

Lossless – which, for audio, translates to noiseless – coding with perfect reconstruction would be an optimum system, since no information would be lost or altered. It may seem that lossless, redundancy-reducing methods (such as PKZIP, Stuffit, Stacker, and others used in computer hard-disk compressions) would be applicable to audio. Unfortunately, no constant compression rate is possible due to signal-dependent variations in redundancy: there are highly redundant signals like constant sine tones (where the only information necessary is the frequency, phase, amplitude, and duration of the tone), while other signals, such as those which approach broadband noise, may be completely unpredictable and contain no redundancy at all. Furthermore, looking for redundancy can take time: while a popular song *might* have three choruses with identical audio data that would need to be coded only once, you'd have to store and analyze the entire song in order to find them. Any system intended for a real-time use must have a consistent output rate and be able to accommodate the worst case, so effective audio compression is impossible with redundancy reduction alone.

Fortunately, psychoacoustics permits a clever solution! Effects called “masking” have been discovered in the human auditory system. These masking effects (which merely prove that our brain is also doing something similar to bit rate reduction) have been found to occur in both the frequency and time domains and can be exploited for audio data reduction.

Most important for audio coding are the effects in the frequency domain. Research into perception has revealed that a tone or narrow-band noise at a certain frequency inhibits the audibility of other signals that fall below a threshold curve centered on a masking signal.

The figure below shows two thresholds of audibility curves. The lower one is the typical frequency sensitivity of the human ear when presented with a single swept tone. When a single, constant tone is added, the threshold of audibility changes, as shown in the upper curve. The ear's sensitivity to signals near the constant tone is greatly reduced. Tones that were previously audible become “masked” in the presence of “masking tones,” in this case, the one at 300Hz.

All signals below the upper “threshold of audibility” curve, or “masking threshold,” are not audible, so we can drop them out or quantize them crudely with the least number of bits. Any noise which results from crude quantization will not be audible if it occurs below the threshold of masking. The masking depends upon the frequency, the level, and the spectral distribution of both the masker and the masked sounds.

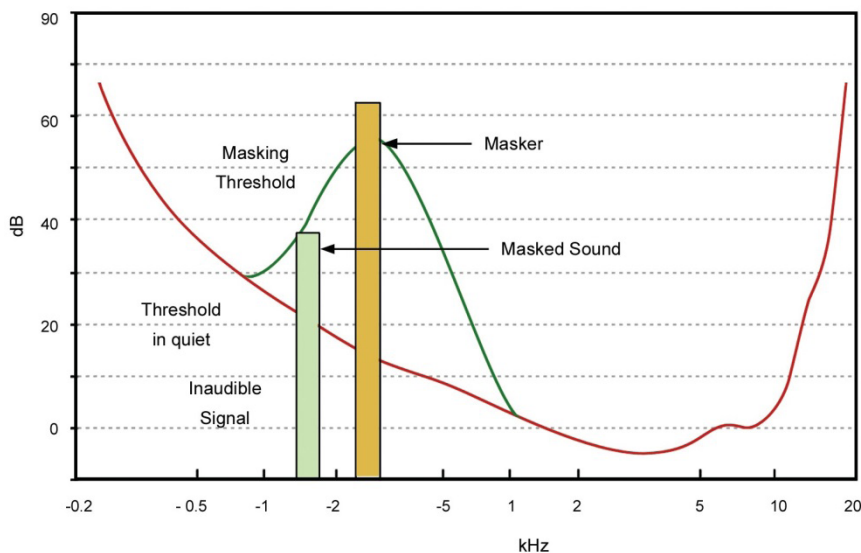

Masking effects in the frequency domain. A masking signal inhibits audibility of signals adjacent in frequency and below the threshold.

To benefit from the masking effects, perceptual coders use a filter bank to divide the input audio into multiple bands for analysis and processing. The maximum masked noise level is calculated depending on the spectral content, and the available bits are allocated so as to keep the quantization noise below the masking threshold at every point in the spectrum.

While coding efficiency increases with more bands and better frequency resolution, the time domain resolution decreases simultaneously, owing to an inevitable side effect of the band filtering process: higher frequency resolution requires a longer time window – which limits time resolution. Happily, masking works also in the time domain. A short time before and a longer time after a tone is switched on and off, other signals below a threshold amplitude level are not noticeable. Filter banks with higher frequency resolution naturally exploit the ear’s time-masking properties.

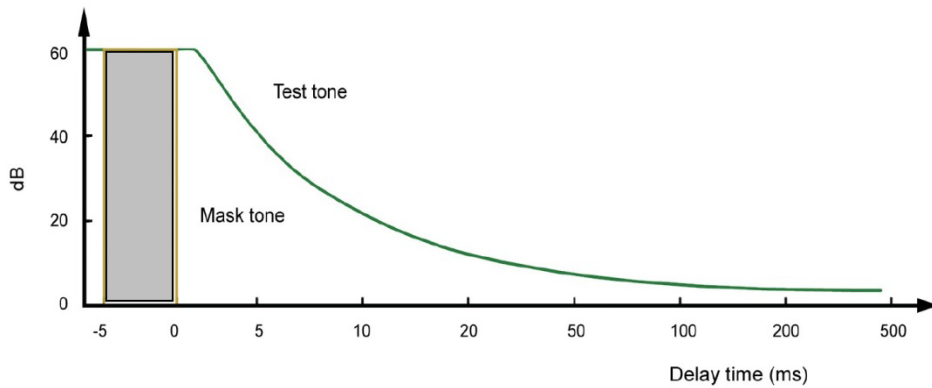

Making effects in the time domain. Masking occurs both before and after the masking signal.

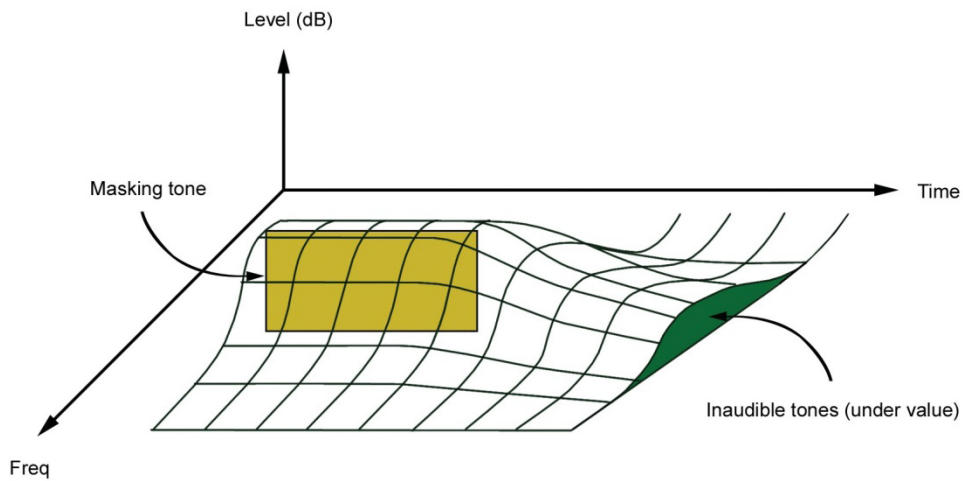

The combined results of time and frequency versus masking. Signals under the curve are inaudible.

Important!

Due to a perceptual coder's reliance on precisely modeling principles of human perception, audio to be coded should not be processed with any non-linear dynamics processing, such as clipping, multi-band compression, or hard limiting. Wideband compression, or AGC, is acceptable, and may be desirable if consistent level cannot otherwise be achieved.

The same is true of audio that has been decoded, after passing through a perceptual coding cycle, but to a much lesser degree.

For more information on this, follow the link to our Omnia Audio website that has a paper delivered at the AES by Frank Foti on this topic: <http://omniaaudio.com/techinfo/default.htm>

The steps involved in the perceptual coding process are shown below:

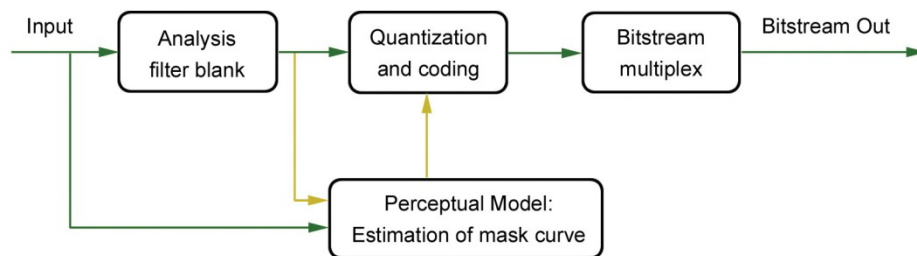

The components work as follows:

- ◆ The analysis filter bank divides the audio into spectra components. Sufficient frequency resolution must be used in order to exceed the width of the ear's critical bands, which is 100Hz below 500Hz, and 20% of the center frequency at higher frequencies.
- ◆ The estimation of masked threshold section is where the human ear/brain system is modeled. This determines the masking curve, under which noise must fall.
- ◆ The audio is reduced to a lower bit rate in the quantization and coding section. On the one hand, the quantization must be sufficiently coarse in order to not exceed the target bit rate. On the other hand, the error must be shaped to be under the limits set by the masking curve.
- ◆ The quantized values are joined in the bit stream multiplex, along with any side information.

Doing audio coding effectively means managing several tradeoffs. Most important is the number of samples coded together in one frame. Long frames have high delay, but are more efficient because the header and side information is transmitted less frequently. Longer frames offer the possibility to use filter banks with better frequency resolution. A fundamental principle in signal processing is that spectral splitting filters may have either good time resolution, or good frequency resolution, but not both. This makes sense when you consider that a longer time window means that the analyzer has more complete information – more full audio cycles to work with.

In the case of rapidly changing input signals (transients), long frames are poorer than short ones because the time spread will lead to so-called “pre-echoes.” For such signals, the size of the frame should correspond to the temporal resolution of the human ear. This can be achieved by using short frames or by changing the frame length according to the immediate characteristics of the signal.

MPEG

By far, the most popular high fidelity audio coders rely upon techniques developed under the MPEG umbrella. MPEG stands for Motion Pictures Expert Group, a joint committee of the International Standards Organization (ISO) and the International Electrotechnical Commission. Three decades ago, when the CD had just been introduced, the first proposals for audio coding were greeted with suspicion and disbelief. There was widespread agreement that it would simply not be possible to satisfy golden ears while deleting 80% or more of the digital audio data. But the audio coding pioneers were persistent, and the MPEG audio group was formed. Since 1988, they have been working on the standardization of high quality audio coding. Today, almost all agree not only that audio bit rate reduction is effective and useful, but that the MPEG process has been successful at picking the best technology and encouraging compatibility across a wide variety of equipment.

The MPEG process is open and competitive. A committee of industry representatives and researchers meet to determine goals for the target bit rate, quality levels, application areas, testing procedures, etc. Interested organizations that have something to contribute are invited to submit their best work. A careful double blind listening test series is then conducted to determine which of the entrant's technologies delivers the highest performance. The subjective listening evaluations are done at various volunteer organizations around the world that have access to both experienced and inexperienced test subjects. Broadcasters are the most common participants, with many of the important test series conducted at the BBC in England, the CBC in Canada, and NHK in Japan. Finally, results are tabulated, a report is drafted, and ultimately a standard is issued.

In 1992, under MPEG1 (the first of the MPEG standards), this process resulted in the selection of three related audio coding methods, each targeted to different bit rates and applications. These are the famous layers: 1, 2, and 3. As the layer number goes up, so does performance and implementation complexity. Layer 1 is not much used. Layer 2 is widely used for Digital Audio Broadcasting (DAB) in Europe, audio for video, and broadcast play-out systems. Layer 3 – which Telos was the first to use in the Zephyr – is widely used in broadcast codecs and has gone on to significant Internet and consumer electronics fame under the moniker derived from the file extension: MP3. MPEG2 opened the door for new work, and some minor improvements were added to both Layers 2 and 3. In 1997, the first in the AAC family was added to the MPEG2 standard. MPEG4 is ongoing now, but it has already been decided that AAC will be the “general audio” coder under this umbrella. (MPEG3 was skipped for reasons unknown)

MPEG4 AAC (Advanced Audio Coding)

The MPEG4 AAC system is the newest audio coding method selected by MPEG. It is a fully state-of-the-art audio compression tool that provides performance superior to any known approach at bitrates greater than 64kbps, and excellent performance relative to the alternatives at bitrates reaching as low as 16kbps.

The idea that led to AAC was not only to start fresh, but also to combine the best work from the world's leading audio coding laboratories: Fraunhofer, Dolby, Sony, and AT&T were the primary collaborators that offered components for AAC. The hoped-for result was ITU (International Telecommunications Union) “indistinguishable quality” at 64 kbps per mono channel. That is, quality indistinguishable from the original, with no audio test item falling below the “perceptible, but not annoying” threshold in controlled listening tests.

The MPEG test items include the most difficult audio known to codec researchers, so this was a daunting challenge. The thinking was that if a codec could pass this test, it would surely be transparent for normal program material like voice and pop music, which are much easier to encode. AAC designers chose to use a new modular approach for the project, with components being plugged in to a general framework, in order to match specific application requirements and the always-present performance/complexity/delay tradeoffs.

Compared to the previous layers, AAC takes advantage of such new tools as temporal noise shaping, backward-adaptive linear prediction, and enhanced joint stereo coding techniques. AAC supports a wide range of sampling rates (8-96 kHz), bit rates (16-576 kbps) and from one to 48 audio channels.

AAC is a lot more sophisticated than the previous MPEG layers 2 and 3, providing significantly more coding power. Because it uses a modular approach, new ideas can be developed and plugged into the basic structure. This had the additional advantage that it was possible to combine the various components from different developers, taking the best pieces from each. AAC was built on a similar structure to Layer 3, and thus retains most of its features. Nevertheless, compared to the previous MPEG layers, AAC benefits from some important new additions to the coding toolkit:

- ◆ An improved filter bank with a frequency resolution of 2048 spectral components, nearly four times the number used by Layer 3
- ◆ Temporal Noise Shaping, a new and powerful element that minimizes the effect of temporal spread. This benefits voice signals, in particular.
- ◆ A prediction module guides the quantizer to very effective coding when there is a noticeable signal pattern, like high tonality.
- ◆ Perceptual Noise Shaping allows a finer control of quantization resolution, so bits can be used more efficiently.

Because it uses this modular approach, an implementer may pick and choose among the component tools to make a product with appropriate performance/complexity ratios. Or, new modules can be developed later and “plugged in” to its basic structure. Three default profiles have been defined, using different combinations of the available tools:

- ◆ Main Profile – uses all tools, except the gain control modules. Provides the highest quality for applications where the amount of random access memory (RAM) needed is not constrained
- ◆ Low-complexity Profile – deletes the prediction tool and reduces the temporal noise-shaping tool in complexity
- ◆ Sample-rate Scalable (SRS) Profile – adds the gain control tool to the low complexity profile, allowing the least-complex decoder

The block diagram of the AAC encoder is shown below. It is considerably more sophisticated than the previous MPEG Layer 2 and Layer 3 systems, and therefore offers more coding power:

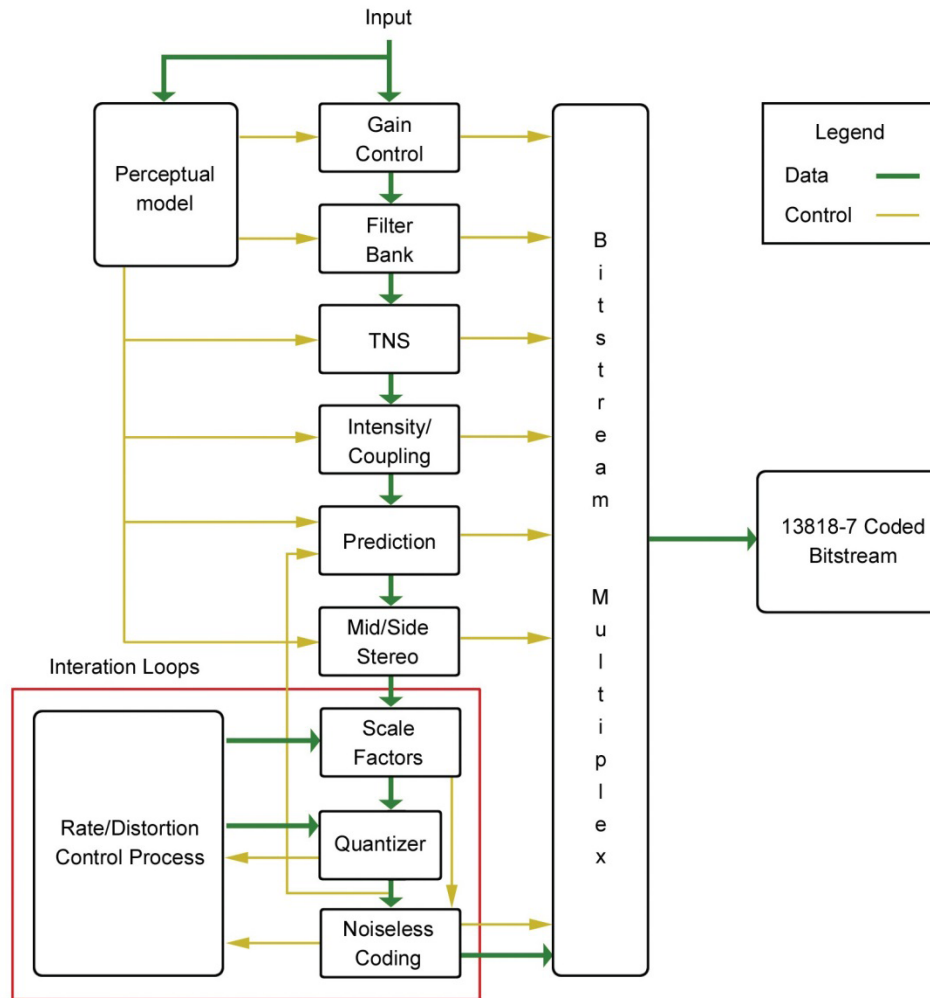

Because AAC was built on a similar structure to Layer 3, it therefore retains some of its powerful features:

- ◆ Redundancy Reduction – a Huffman encoding process causes values that appear more frequently to be coded with shorter words, while values that appear only rarely are coded with longer words. This results in an overall increase in coding efficiency with no degradation, since it is a completely lossless process.
- ◆ Bit Reservoir Buffering – often, there are some critical parts in a piece of music that cannot be encoded at a given data rate without audible noise. These sequences require a higher data rate to avoid artifacts. On the other hand, some signals are easy to encode. If a frame is easy, then the unused bits are put into a reservoir buffer. When a frame comes along that needs more than the average amount of bits, the reservoir is tapped for extra capacity.
- ◆ Ancillary Data – the bit reservoir buffer offers an effective solution for the inclusion of such ancillary data as text or control signaling. The data is held in a separate buffer and gated onto the output bit stream using some of the bits allocated for the reservoir buffer, when they are not required for audio.
- ◆ The Joint Stereo mode takes advantage of the redundancy in stereo program material. The encoder switches from discrete L/R to a matrixed L+R/L-R mode dynamically, depending on the program material

The result of all this is that the researchers succeeded: AAC provides performance superior to any known codec at bitrates greater than 64kbps, and excellent performance relative to the alternatives at bitrates reaching as low as 16kbps.

And the researchers succeeded in achieving the ITU goal: AAC is the first codec system to fulfill the ITU requirements for indistinguishable quality at 128 kbps/stereo. It has approximately 100% more coding power than Layer 2 and 30% more power than the former MPEG performance leader, Layer 3. It offers:

- ◆ 20kHz mono or stereo audio bandwidth
- ◆ Significantly less delay than MPEG2 layers 2 or 3
- ◆ Full-fidelity mono on a single 56kbps channel
- ◆ Affordable, transparent audio transmission for AM/FM radio or television audio

For more information on AAC, and the tests of it, see our web site for a paper on the subject: www.zephyr.com

AAC-LD (AAC Low Delay)

When announcers use codecs for broadcast remote applications, they often need to have a natural two-way interaction with other program participants located back at the studio, or callers. Because it is a hot topic for engineers working in the field of Internet telephony, a number of studies have been conducted to determine users' reactions to delays in telephone conversations. The data apply directly to the application of professional codecs to remotes, so it is interesting to take a peek over the shoulder of the telecom guys to see what they have learned.

For broadcast remotes, we try to arrange our system so that there is no path for the field announcer's voice to return to his/her headphones. Nevertheless, sometime echo is unavoidable. For example, this can happen when a telephone hybrid has leakage, or when a studio announcer has open-air headphones turned up loud, and the audio makes its way into the studio microphone.

When there is no echo, it has been discovered that anything less than 100ms one-way delay permits normal interaction between participants. Between 100 and 250ms is considered "acceptable." ITU-T standard G.114 recommends 150ms as the maximum for "good" interactivity. Echo introduces a different case. As you might expect, echo is more or less annoying depending upon both the length of time it is delayed and its level. Telephone researchers have measured and quantified reactions, and ITU-T G.131 reports the findings and makes recommendations.

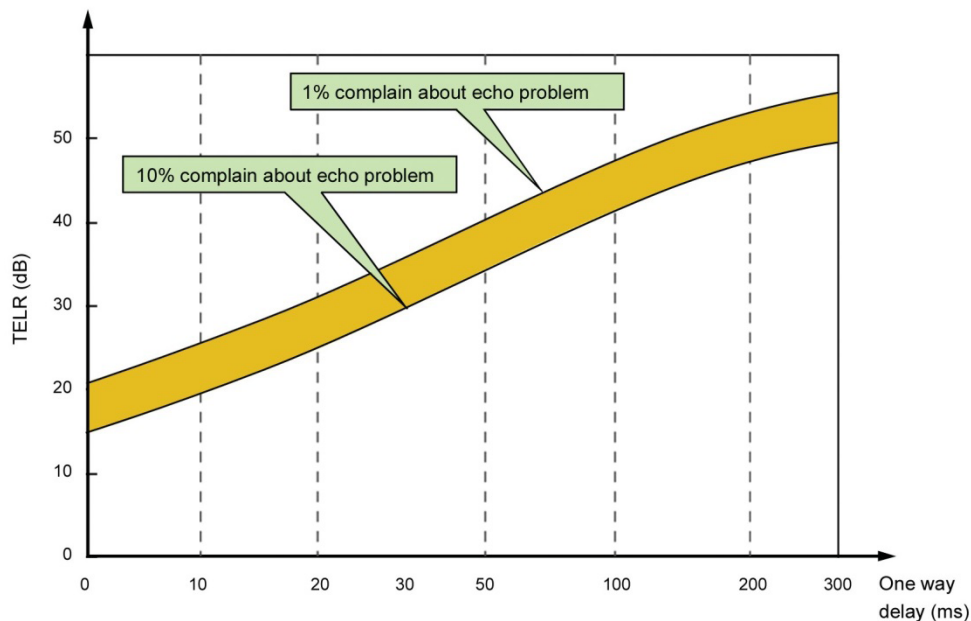

Summary of ITU-T G.131 with recommendations for designers of telephone systems that must cope with echo. This shows Talker Echo Loudness Rating versus Delay

There are codecs using other than perceptual technologies that have lower delay, but they are not as powerful. That is, for a given bitrate, they do not achieve fidelity as good as the MPEG systems we have been examining. The common G.722 is an example. It uses ADPCM (Adaptive Delta Pulse Code Modulation), which can have a delay as low as 10ms, but with much poorer quality. So the question arises: Is it possible to have high quality and low delay in the same codec? Until recently, the answer was no. But new developments in codecs have changed the picture. One of the main objectives in audio coding is to provide the best tradeoff between quality and bit rate. In general, this goal can only be achieved at the cost of a certain coding delay. Codecs for voice telephone applications have used ADPCM and CELP because they have much lower delay than perceptual codecs. These are optimized for voice and can have reasonable good performance.

Zephyr users have known for years that Layer 3 offers all the fidelity needed for most broadcast situations. However, they also know that the delay of Layer 3 can be frustrating, particularly if high fidelity is needed in both directions and parties at the two ends must carry on a conversation.

The folks at Fraunhofer were aware of these factors, and have developed an extension to AAC called “AAC Low Delay,” or “AAC-LD” for short. AAC-LD offers quality equivalent to Layer 3 with less than 25% of the delay!

AAC-LD combines the advantages of perceptual coders (such as Layer 3) with certain principles of speech coders. Compared to speech coders, AAC-LD handles both speech and music with good quality. Unlike speech coders, however, audio quality scales up with bit rate, and transparent quality can be achieved. AAC-LD’s coding power is roughly the same as Layer 3, meaning that mono high fidelity 15kHz audio may be sent at 64kbps. At 128kbps, you achieve near CD quality stereo audio.

Delay in perceptual codecs is dependent on several parameters:

- ◆ Frame length – Time is required to collect all the samples for a frame. The longer the frame, the more the delay
- ◆ Filter bank decay – This causes an additional delay equivalent in time to the frame delay.
- ◆ Look-ahead delay for block switching – Layer 3 and AAC use filter banks with high frequency resolution. For signals with high tonality, efficiency is high. But when there are transients, a dynamic switching process changes to a filter bank with lower frequency resolution and better time resolution. In order to correctly decide when to make this change, a look-ahead process is required, adding delay.
- ◆ Bit reservoir – the length of this buffer determines how much delay this process contributes

The overall delay is a combination of all these components, divided by the sampling rate. The delay scales linearly and inversely with the sampling frequency.

How AAC-LD Gets its Low Delay

AAC-LD is based on the core AAC framework, so much is similar, but each of the contributors to the delay had to be addressed and modified:

- ◆ The frame length is reduced to 512 or 480 samples, with the same number of spectral components at the filter bank output
- ◆ No dynamic block switching is used because the required look-ahead delay is too long. The temporal problem that causes pre-echoes is handled by the Temporal Noise Shaping modules.
- ◆ The “window shape” of the spectral filter is enhanced to be adaptive. Normally, the shape is a simple sine curve, but AAC-LD can use a shape that has a lower overlap between the bands. This significantly improves performance with transients, without adding any delay.

MPEG-4 High Efficiency AAC (HE-AAC, previously known as “aacPlus™”)

HE-AAC is an extension of AAC with the addition of Spectral Band Replication, a technique (developed by Coding Technologies) of synthesizing high frequency audio content based on the lower frequency data and side-chain information. SBR dramatically increases the efficiency of coding when using low bitrates. HE-AAC v1 is AAC plus SBR, while HE-AAC v2 adds parametric stereo to further increase the efficiency of coding stereo signals. For more on the SBR technology, see the papers on the Telos web site about “aacPlus,” which was the name of this codec before acceptance by MPEG.

MPEG-4 Enhanced Low Delay AAC

High audio quality, low coding delay, and very low data rates: AAC Enhanced Low Delay (AAC-ELD) is the perfect choice for any delay sensitive application that demands full audio bandwidth at data rates down to 24kbps.

AAC-ELD combines the strengths of its two main components, MPEG-4 AAC Low Delay and Spectral Band Replication (SBR). Whereas MPEG-4 AAC-LD features low encoding/decoding latency, SBR provides high quality audio at very low bit rates. SBR is also used in MPEG-4 HE-AAC, one of today’s most efficient audio codecs.

AAC-ELD became an MPEG standard in January 2008.

ISO/MPEG Layer 2

MPEG Layer 2 was an extremely popular early perceptual coding method, primarily because it’s easier and less expensive to implement – particularly at the encoder – and practical devices using it were available earlier than Layer 3. It’s a preferred choice for applications where very large data capacity is available, such as satellite links, high capacity Primary ISDN or T1 circuits, and hard disk storage systems using Ethernet for signal distribution.

We include it in the Z/IP ONE to offer compatibility with the widest variety of codecs, and for use at high bit rates.

Layer 2 J-Stereo

The Layer 2 joint stereo mode uses an “intensity coding” method. This method has high coding power and is quite effective, but hurts stereo separation on some program material. Audio above 3 kHz or so is combined to mono and panned to one of seven positions across the stereo stage.

G.722

This technology pre-dates perceptual coding. It is much simpler than the transform methods, but suffers from poorer audio performance. It has the benefit of low cost and the unique advantage of low delay. It has been around as an international standard the longest, and is probably the most widely used system. In our view, this technology is acceptable for mono voice where high fidelity is not necessary. It is good also for cueing and intercom channels.

We have included G.722 in the Z/IP ONE because:

- ◆ It had been the most popular coding method early on, so there are many of these codecs in use. Because it is a standard, codecs from various manufacturers have a good probability of being able to interwork with one another.
- ◆ G.722 has the lowest delay of all popular coding methods.

This method was invented in the late 70s and adopted as a standard in 1984 by the CCITT, the Consultative Committee for International Telephony and Telegraphy (renamed as ITU-T in 1993). The technique used is sub-band ADPCM (Adaptive Delta Pulse Code Modulation), which achieves data reduction by transmitting only the difference between successive samples. G.722 does this in two audio frequency sub-bands: 50 Hz to 4 kHz and 4 to 7 kHz.

Deep Tech Note!

Only two bits are allocated per sample for audio frequencies above 4 kHz. This is sufficient for conveying the sibilance in voice signals, but is not very good for intricate musical sounds. Also, the “predictor model” used to determine the step size in the adaptive function is designed only for speech. This is why music transmitted via G.722 has a distinctly “fuzzy” quality.

G.722 has a frequency response extending to 7.5 kHz with fairly poor fidelity. Unless there is no alternative, it should not be used for music.

aptX and aptX Enhanced

Like G.722, aptX also dates from the earliest days of audio coding, and is also based on ADPCM. However, it is designed to run at much higher bit rates, with more bands, and much more faithful audio replication. Due to using ADPCM, rather than psychoacoustic principles, it also has a very low delay. aptX ‘cascades’ well, making it suitable for audio that needs to be recompressed and retransmitted, perhaps several times.

aptX was developed in the 1980s, and became a commercial product in 1990. In 2000, the algorithm was updated into what is now known as aptX Enhanced. Compared with the original aptX, the Enhanced version of the codec features lower delay and better encoding accuracy across the audio frequency range.

Z/IP ONE Specifications

Audio

Line Input:	0dB ref: +4dBu input
THD+N Pro/Pro:	< 0.03% @ +12dBu, 1 kHz Sine
Freq Response:	+/- 1dB 25– 20 kHz
Head Room:	18dB
Dynamic Range:	> 87dB Unweighted > 90 dB“A”Weighted
Crosstalk:	Over 80 dB
Output Clipping:	+22dBu
Output Impedance:	50 Ohm differential
Input Impedance:	6K Ohm differential
Analog to Digital Converter:	24bits
Digital to Analog Converter:	24bits

Physical

Height:	< 43.7 mm (1 Rack Unit per EIA RS-310-C)
Width:	< 482.6 mm (<19" per EIA RS-310-C)
Depth:	180 mm
Weight:	2.5 kg (5 lb)
Power:	115Vac00-240 VAC (50-60 Hz) 14.2 Watts
Temperature:	0-40C (32-104 °F) stirred air
Humidity:	0-98% relative (non-condensing)
Maximum Altitude:	3000m (10,000 ft)

Telos Alliance Limited Warranty

This Warranty covers “the Products,” which are defined as the various audio equipment, parts, software and accessories manufactured, sold and/or distributed by or on behalf of TLS Corp. and its affiliated companies, collectively doing business as The Telos Alliance (hereinafter “Telos”).

With the exception of software-only items, the Products are warranted to be free from defects in material and workmanship for a period of five (5) years from the date of receipt of such Product by the end-user (such date of receipt the “Receipt Date”). Software-only items are warranted to be free from defects in material and workmanship for a period of 90 days from the Receipt Date. Telos will repair or replace (in its discretion) defective Products returned to Telos within the warranty period, subject to the provisions and limitations set forth herein.

This warranty will be void if the Product: (i) has been subjected, directly or indirectly, to Acts of God, including (without limitation) lightning strikes or resultant power surges; (ii) has been improperly installed or misused, including (without limitation) the failure to use telephone and power line surge protection devices; (iii) has been damaged by accident or neglect. As with all sensitive electronic equipment, to help prevent damage and or loss of data, we strongly recommend the use of an uninterruptible power supply (UPS) with all of our Products. Telos products are to be used with registered protective interface devices which satisfy regulatory requirements in their country of use.

This Warranty is void if the associated equipment was purchased or otherwise obtained through sales channels not authorized by Telos.

EXCEPT FOR THE ABOVE-STATED EXPRESS WARRANTY, TELOS MAKES NO WARRANTIES, EXPRESS OR IMPLIED (INCLUDING IMPLIED WARRANTIES OF MERCHANTABILITY AND FITNESS FOR A PARTICULAR PURPOSE).

In no event will Telos, its directors, officers, employees, agents, owners, consultants or advisors (its “Affiliates”), or authorized dealers or their respective Affiliates, be liable for incidental or consequential damages, or for loss, damage, or expense directly or indirectly arising from the use of any Product or the inability to use any Product either separately or in combination with other equipment or materials, or from any other cause.

In order to invoke this Warranty, the Product must be registered via Telos’ website (found at: <http://telosalliance.com/legal/warranty>) at time of receipt by end-user and notice of a warranty claim must be received by Telos within the above stated warranty period and warranty coverage must be authorized by Telos. Contact may be made via email: support@telosalliance.com or via telephone: (+1) 216-241-7225. If Telos authorizes the performance of warranty service, the defective Product must be delivered to: Telos, 1241 Superior Avenue, Cleveland, Ohio 44114 or other company repair center as may be specified by Telos at the time of claim.

Shipping Costs and Warranty Service:

If the date the customer's notice of warranty claim is received by Telos (such date the "Warranty Claim Notice Date") is within the first 90 days following the Receipt Date, Telos will pay the costs of shipping such warranted Product to and from the end user's location, and the cost of repair or replacement of such warranted Product.

If the Warranty Claim Notice Date occurs after the first 90 days following the Receipt Date and before the end of the second (2nd) year, the customer will pay the freight to return the warranted Product to Telos. Telos will then, at its sole discretion, repair or replace the warranted Product and return it to the end user at Telos' expense.

If the Warranty Claim Notice Date occurs between the end of the second (2nd) year following the Receipt Date and the completion of the fifth (5th) year, the customer will pay the costs of shipping such warranted Product to and from the end user's location. Telos will then, in its sole discretion, repair or replace the warranted Product at Telos' expense. Telos also reserves the right, if it is not economically justifiable to repair the warranted Product, to offer a replacement product of comparable performance and condition direct to the customer at a discounted price, accepting the failed warranted Product as a trade-in.

The end user will in all cases be responsible for all duties and taxes associated with the shipment, return and servicing of the warranted Product.

No distributor, dealer, or reseller of Telos products is authorized under any circumstances to extend, expand or otherwise modify in any way the warranty provided by Telos, and any attempt to do so is null and void and shall not be effective as against Telos or its Affiliates.

Out of warranty units returned to the factory for repair may be subject to a \$500 evaluation fee, which fee must be prepaid prior to shipping the unit to Telos. If no repairs are required, the \$500 fee will be retained by Telos as an evaluation charge. If repairs are required, the \$500 fee will be applied to the total cost of the repair.

Safety Notification



This symbol, wherever it appears, alerts you to the presence of uninsulated, dangerous voltage levels inside the enclosure – voltage which may be sufficient to constitute a risk of shock.



This symbol, wherever it appears, alerts you to important operating and maintenance instructions. Read the manual.

1. **Read All Instructions.** All safety and operating instructions must be read before operating the product.
2. **Retain All Instructions.** All safety and operating instructions must be maintained for future reference.
3. **Heed All Warnings.** All warnings on the product and those listed in the operating instructions must be adhered to.
4. **Follow All Instructions.** All operating and product usage instructions must be followed. *If the equipment is used in a manner not specified by the manufacturer, the protection provided by the equipment may be impaired.*
5. **Heat.** This product must be situated away from any heat sources such as radiators, heat registers, stoves, or other products (including power amplifiers) that produce heat.
6. **Water and Moisture.** Do not use this product near water.
7. **Attachments.** Do not use any attachments not recommended by the product manufacturer as they may cause hazards.
8. **Power Sources.** This product must be operated from the type of power source indicated on the marking label and the installation instructions. If you are not sure of the type of power supplied to your facility, consult your local power company.
9. **Grounding and Polarization.** This product is equipped with a polarized AC plug with integral safety ground pin. Do not defeat the safety ground in any manner.
10. **Power Cord Protection.** Power supply cords must be routed so that they are not likely to be walked on or pinched by items placed upon or against them. Pay particular attention to the cords at AC wall plugs and convenience receptacles, and at the point where the cord plugs into the product.
11. **Lightning.** For added protection during a lightning storm, or when the unit is left unattended or unused for long periods of time, unplug the unit from the AC wall outlet. This will prevent damage to the product due to lightning and power surges.
12. **Overloading.** Do not overload AC wall outlets, extension cords, or integral convenience outlets as this can result in a fire or electric shock hazard.

13. **Object and Liquid Entry.** Never push objects of any kind into this product through openings as they may touch dangerous voltage points or short out parts that could result in a fire or electric shock. Never spill liquid of any kind on the product.
14. **Accessories.** Do not place this product on an unstable cart, stand, tripod, bracket, or table. Any mounting of the product needs to follow the manufacturer's instructions.
15. **Servicing.** Refer all servicing to qualified service personnel.
16. **Damage Requiring Service.** Unplug this product from the wall AC outlet and refer servicing to qualified service personnel under the following conditions:
 - ◆ When the AC cord or plug is damaged
 - ◆ If liquid has been spilled or objects have fallen into the product
 - ◆ If the product does not operate normally (following operating instructions)
 - ◆ If the product has been exposed to rain or water
 - ◆ If the product has been dropped or damaged in any way
 - ◆ When the product exhibits a distinct change in performance (outside of normally operating specifications)
17. **Replacement Parts.** When replacement parts are required, be sure the service technician has used replacement parts specified by the manufacturer. Unauthorized substitutions may result in fire, electric shock, or other hazards.
18. **Safety Check.** Upon completing of any repairs to this product, ask the service technician to perform safety checks to determine that the product is in proper operating condition.
19. **Cleaning.** Do not use liquid cleaners or aerosol cleaners. Use only a damp cloth for cleaning the exterior of the product only.